

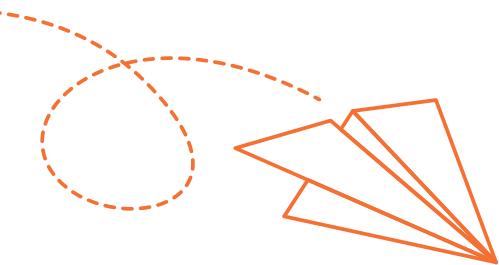

criado por 
Maternidade
com Deus



Aprendendo a fazer

BRINQUEDOS DE PAPEL



criado por 
Maternidade
com Deus

Ele **recebeu do Espírito de Deus talento,**
inteligência e conhecimento **em todas as artes** e
ofícios necessários para a construção.

Êxodo 35:31



Aprendendo a
desenhar 

Por Elisângela Macanhão

E-book: Aprendendo a fazer Brinquedos de papel

Esse material é gratuito. Imagens retiradas da internet de sites gratuitos. Proibida a comercialização.

 [elisangelamacanhao](https://www.instagram.com/elisangelamacanhao)

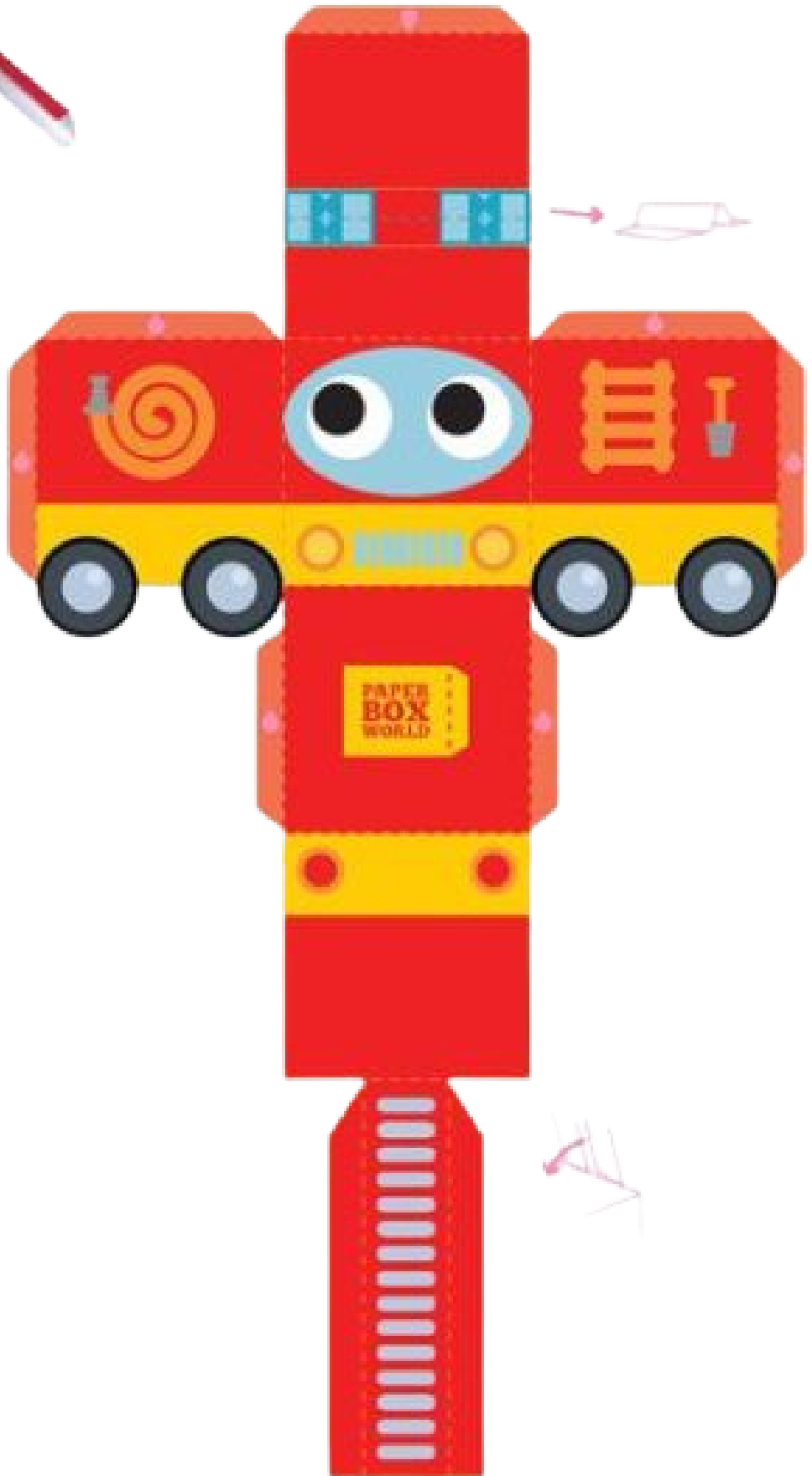

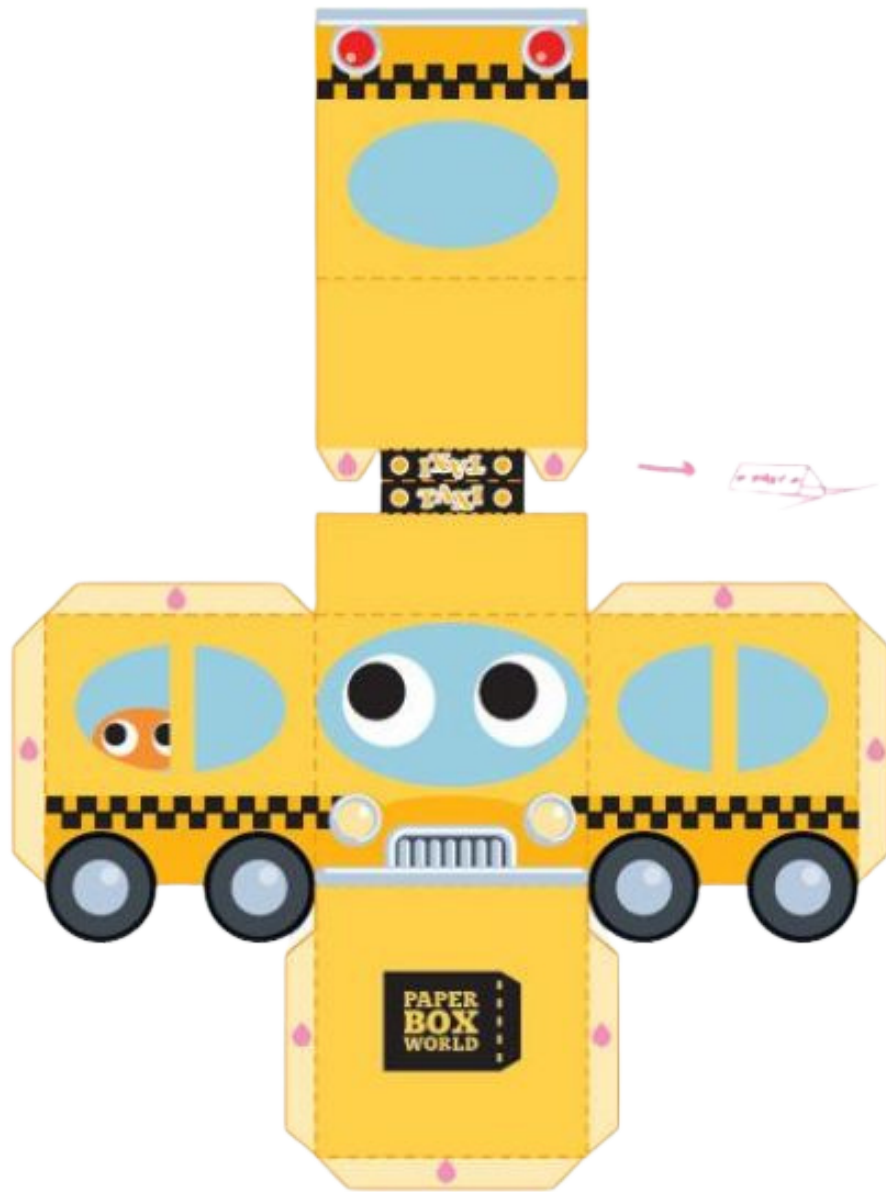

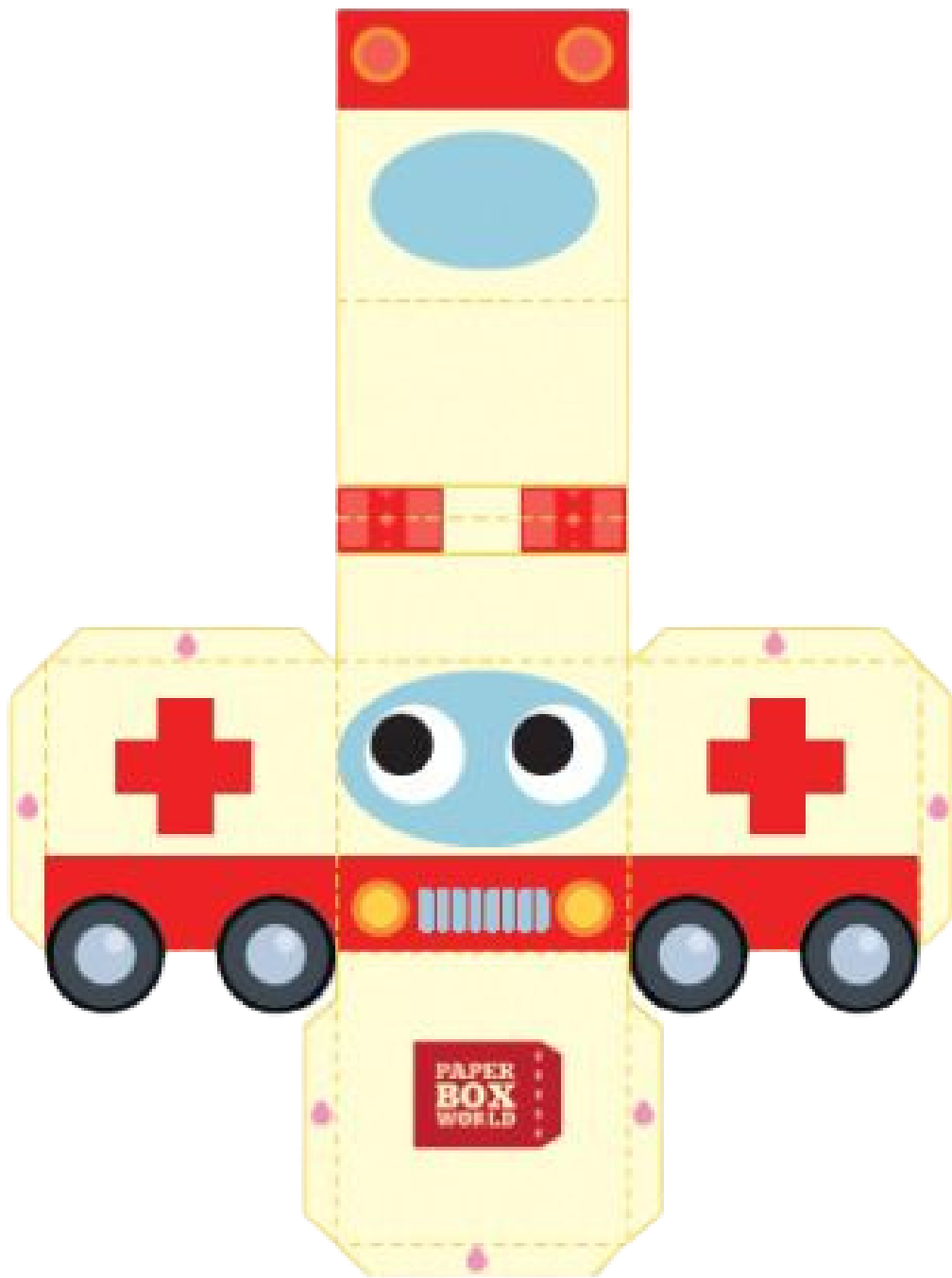

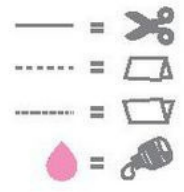
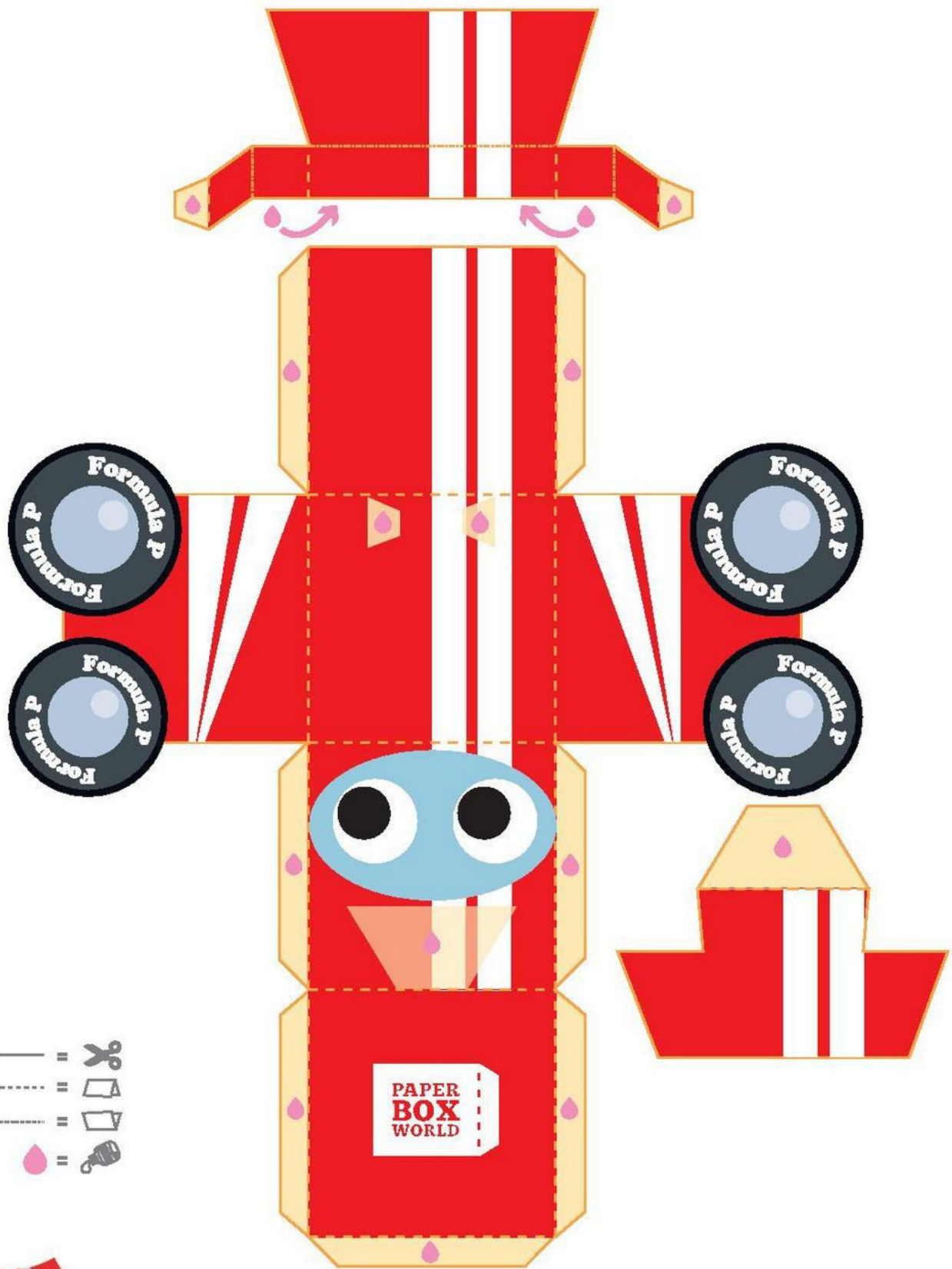



Montanoceratops

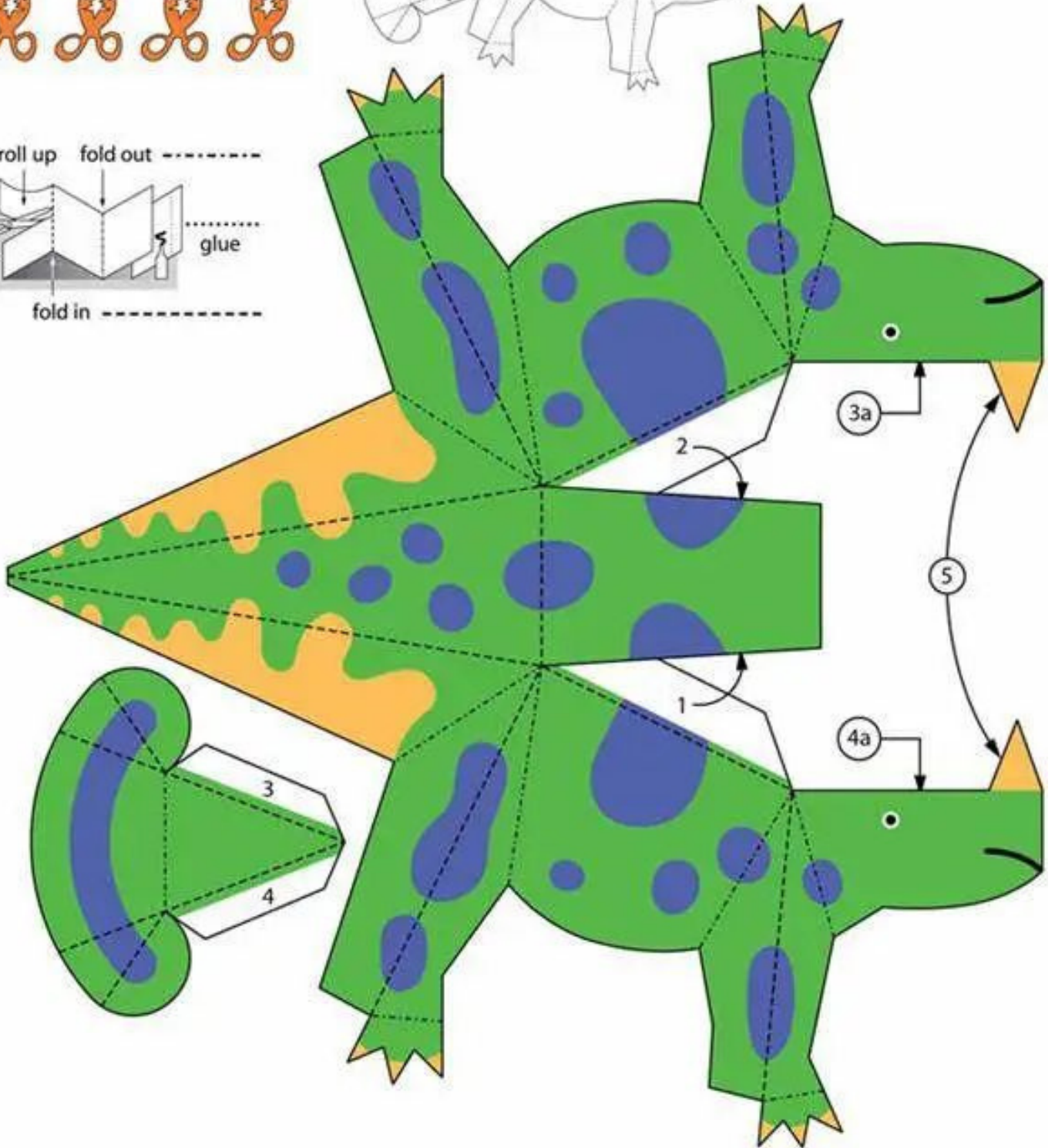
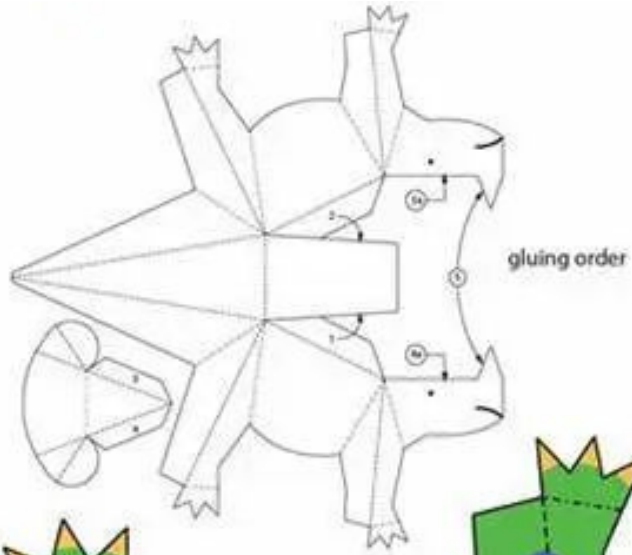
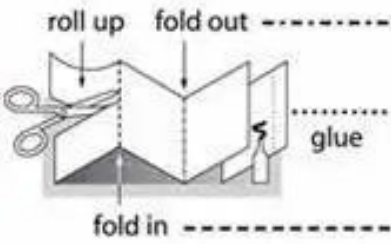



Level ★★★

표현놀이 트리케라톱스

프린 > 접기 > 오리기 > 붙이기 > 트리케라톱스



트리케라톱스

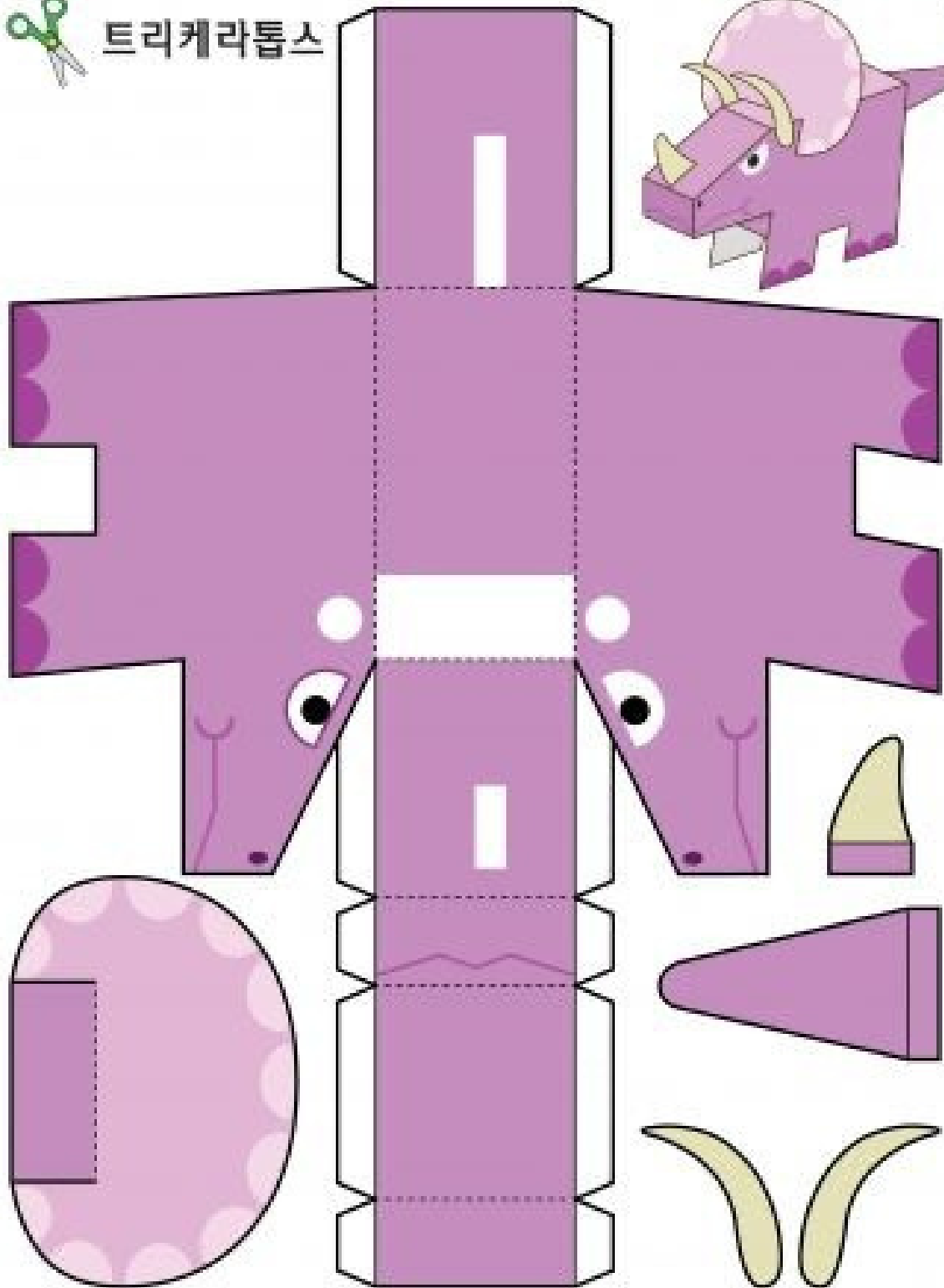
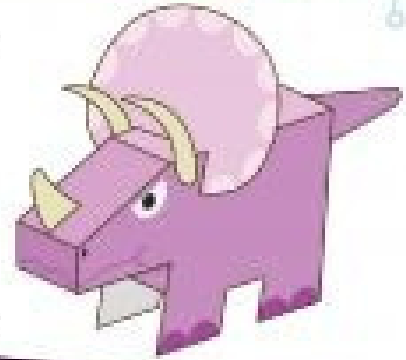

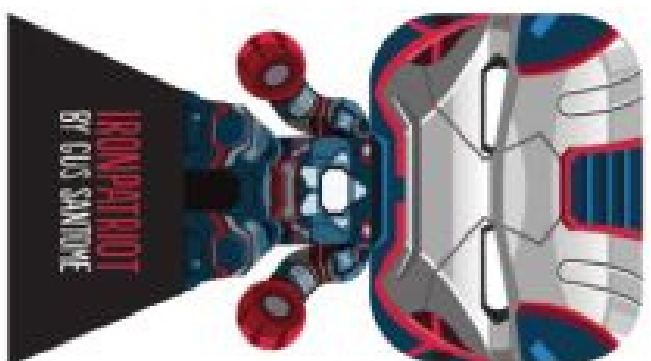
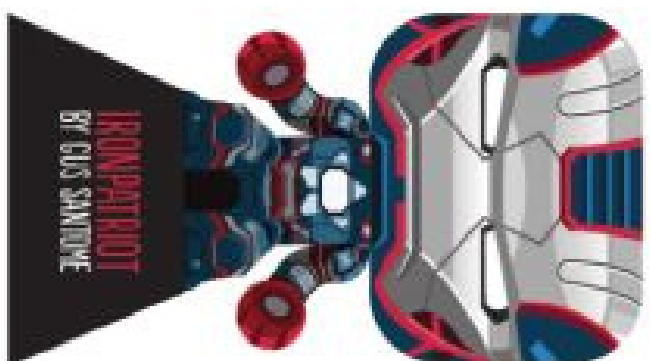
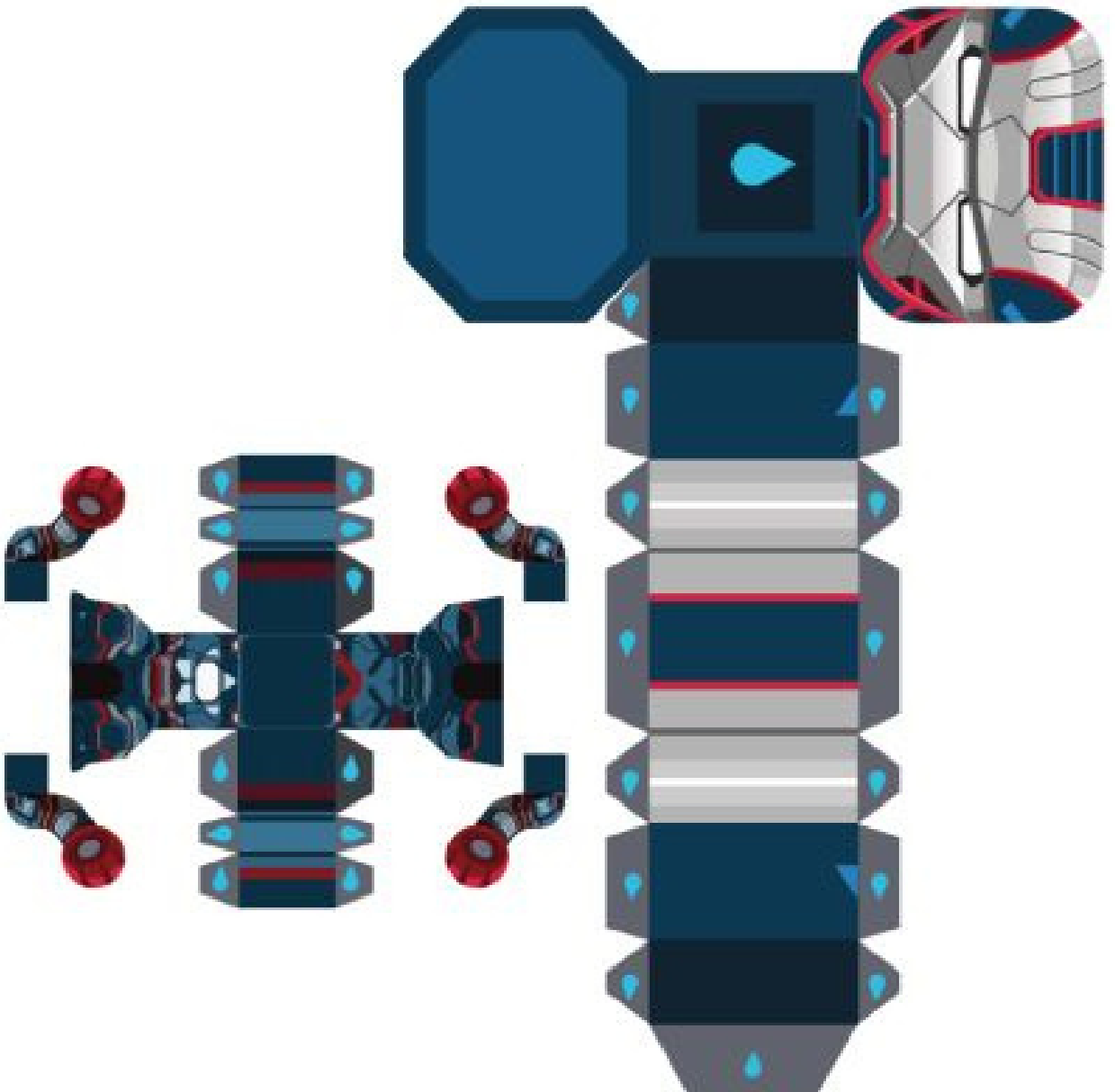

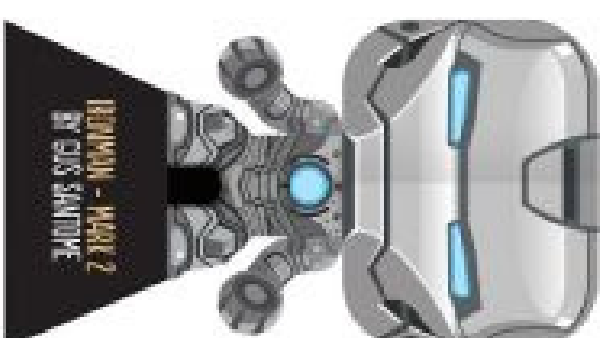
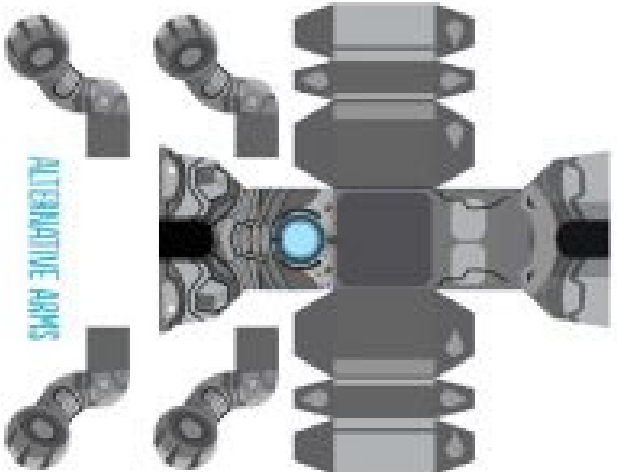
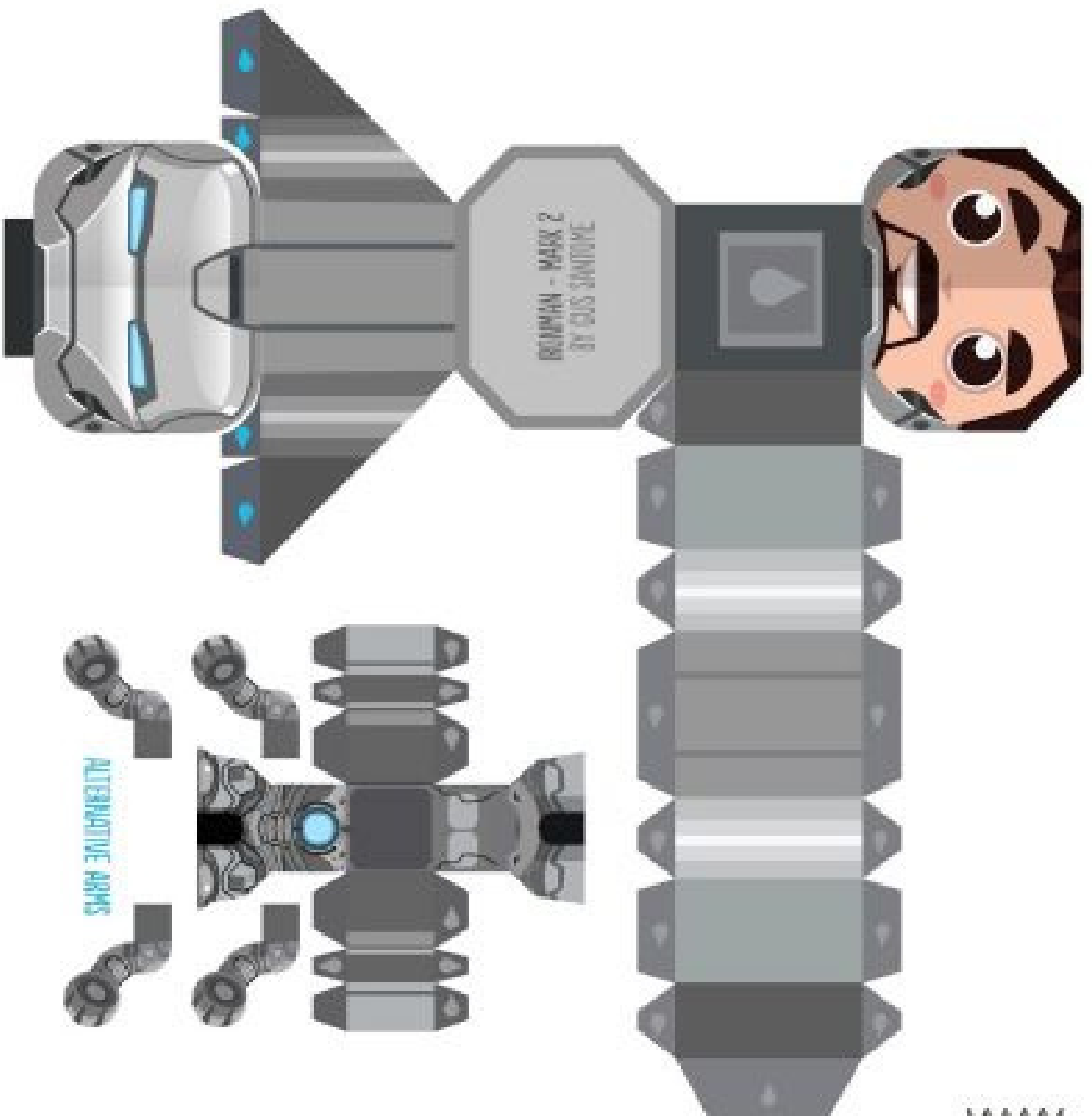

MINIPAPERCRAFT.BLOGSPOT.COM
IRONMAN - MARK 2
BY GUS SANTOYE

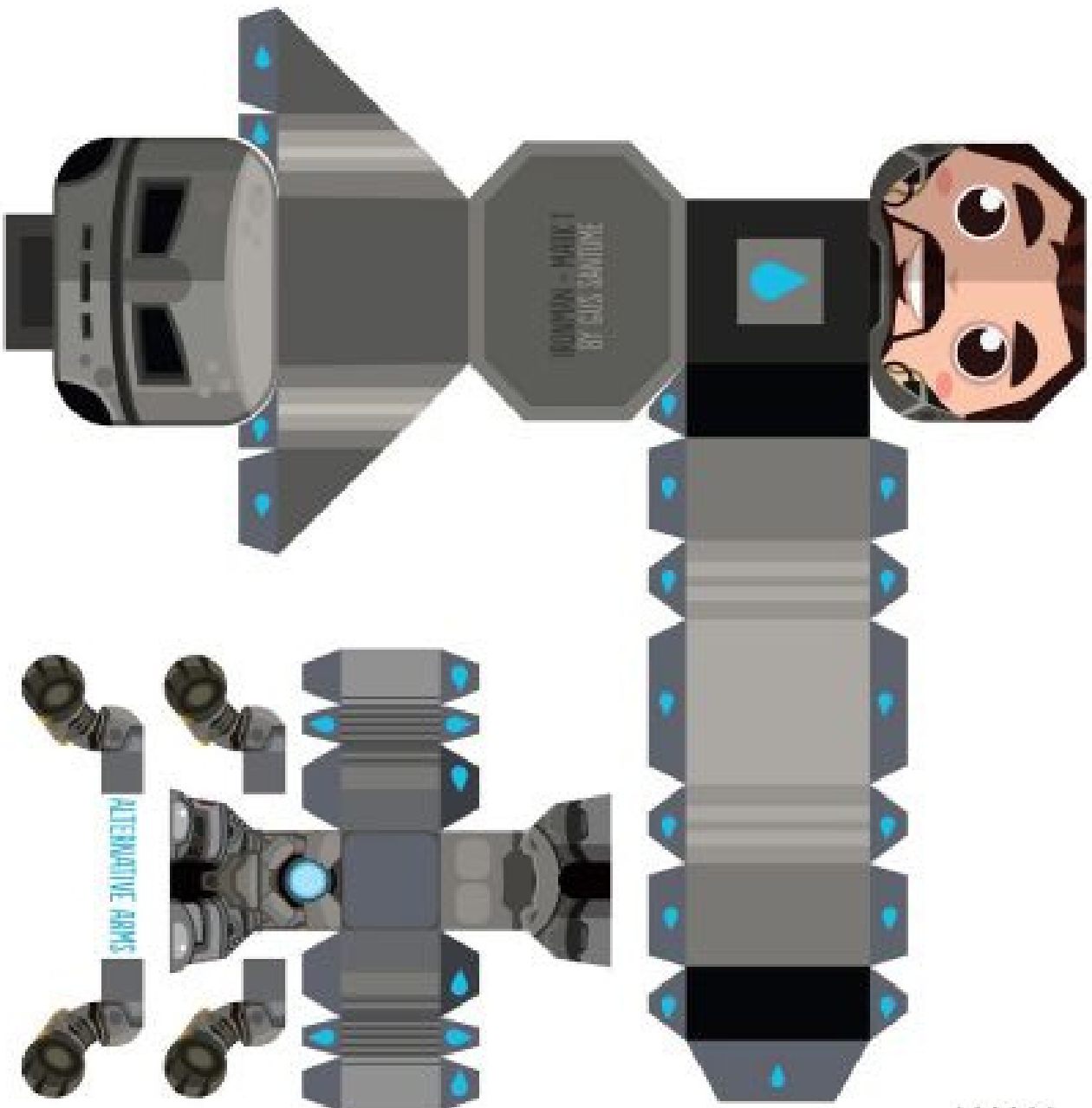

MINIPAPERCRAFT.BLOGSPOT.COM

IRONMAN - MARK 1

BY GUS SANTONE



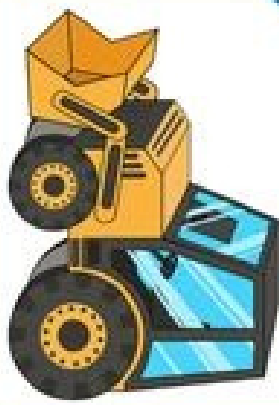
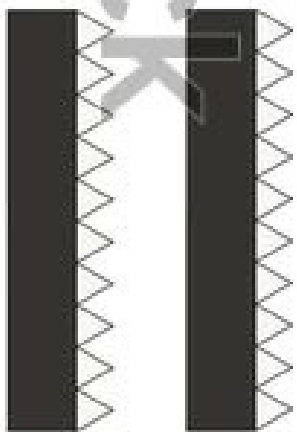
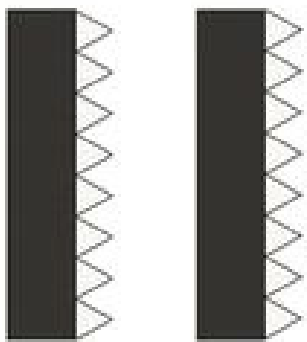
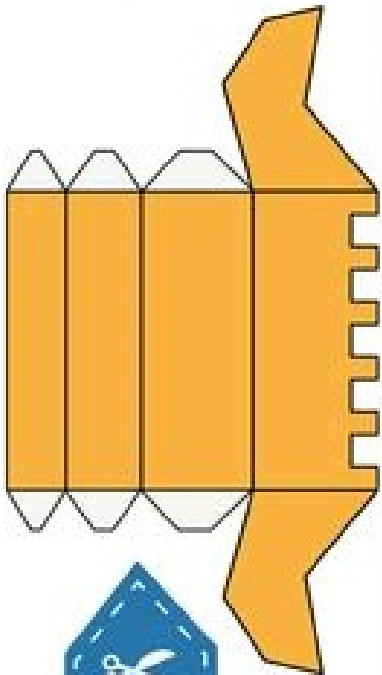
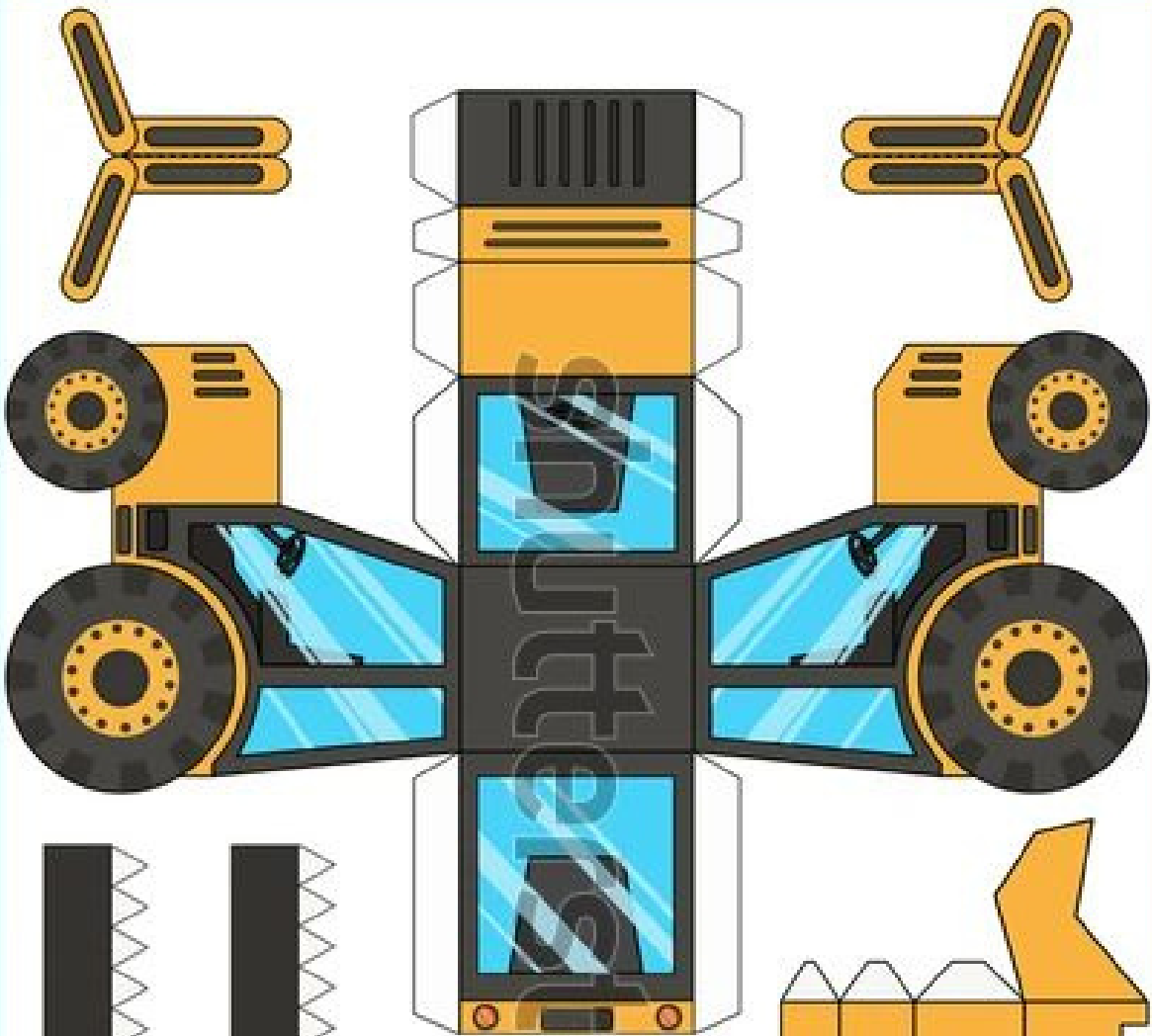

www.shutterstock.com · 1856430916

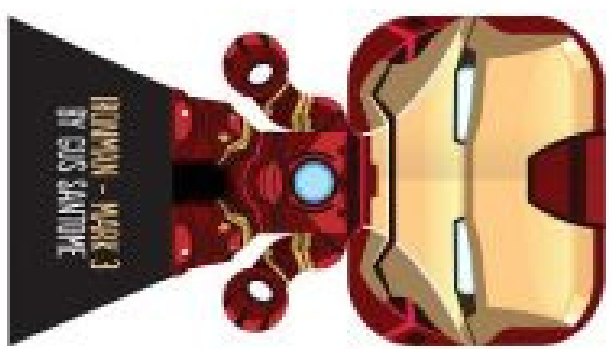
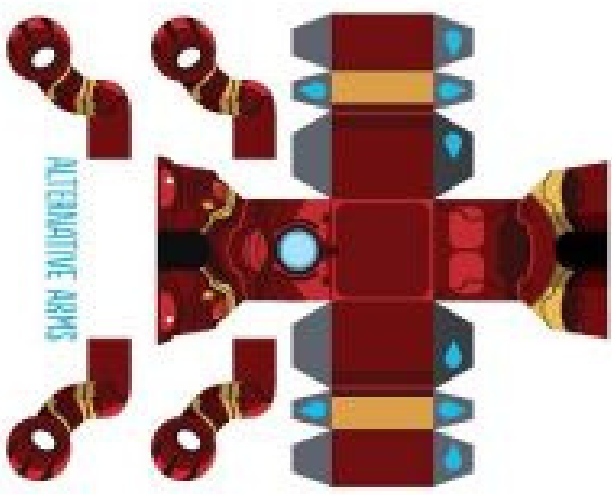
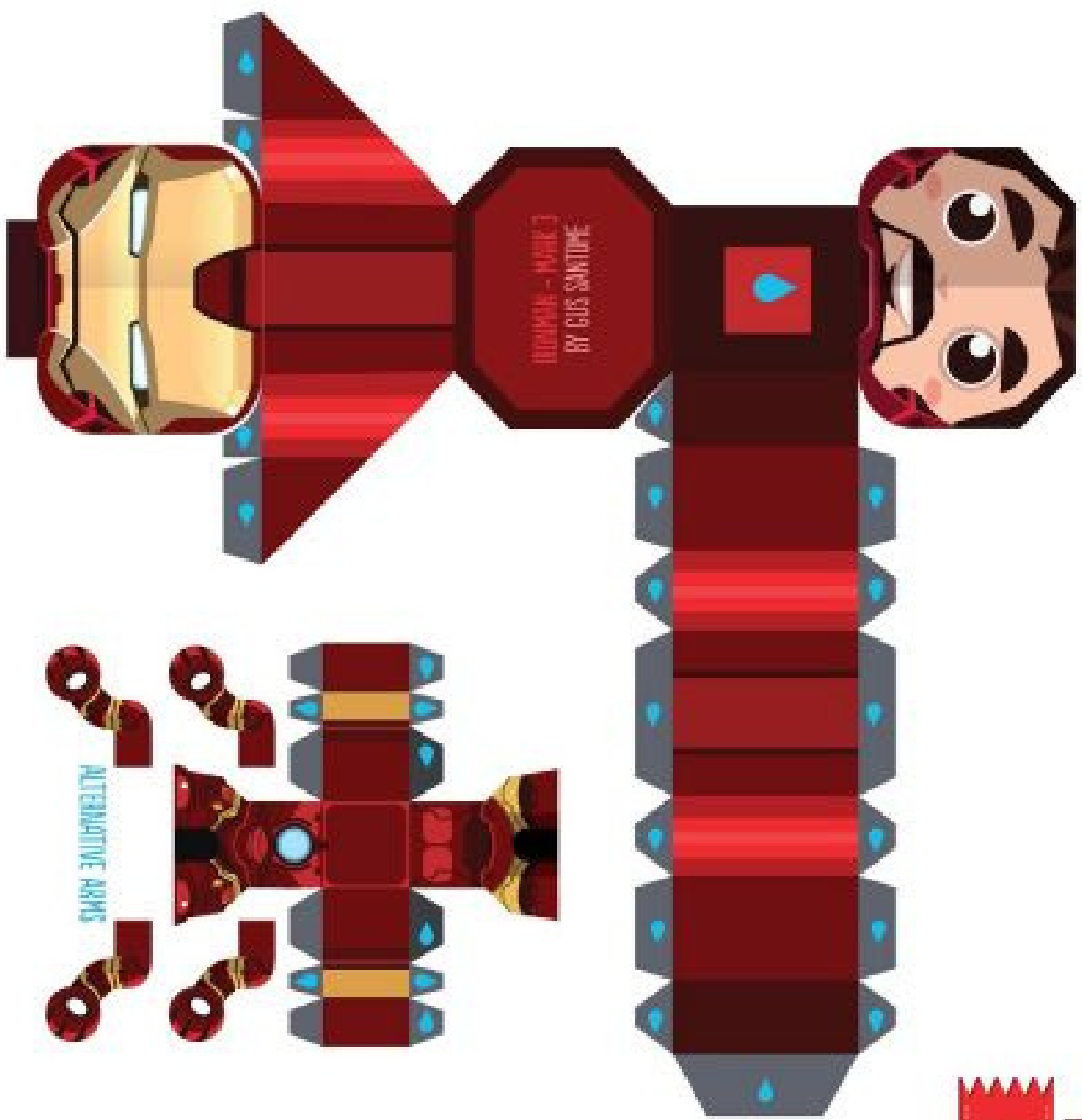

MINIPAPER.CRAFT.BLOGSPOT.COM

IRONMAN - MARK 3

BY GUS SANTONE

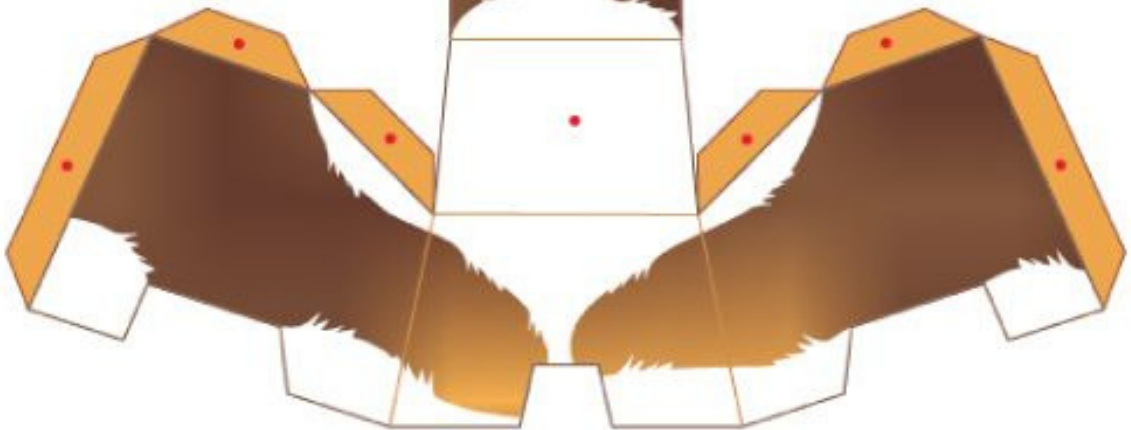
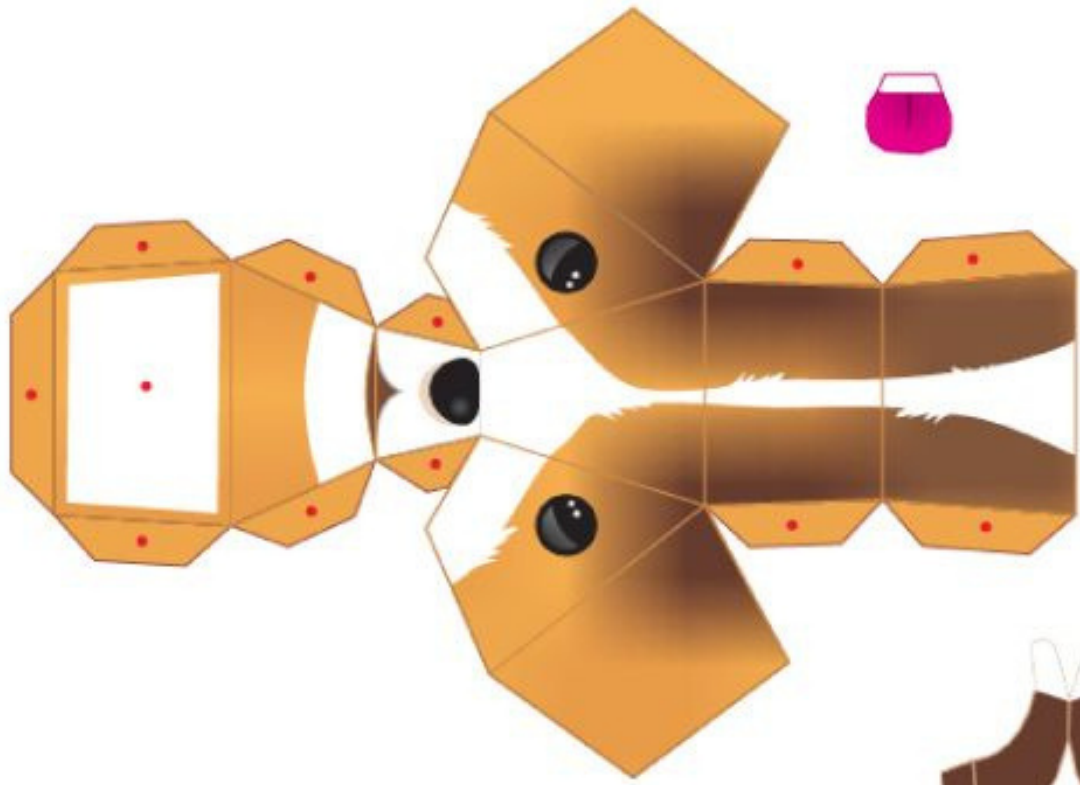

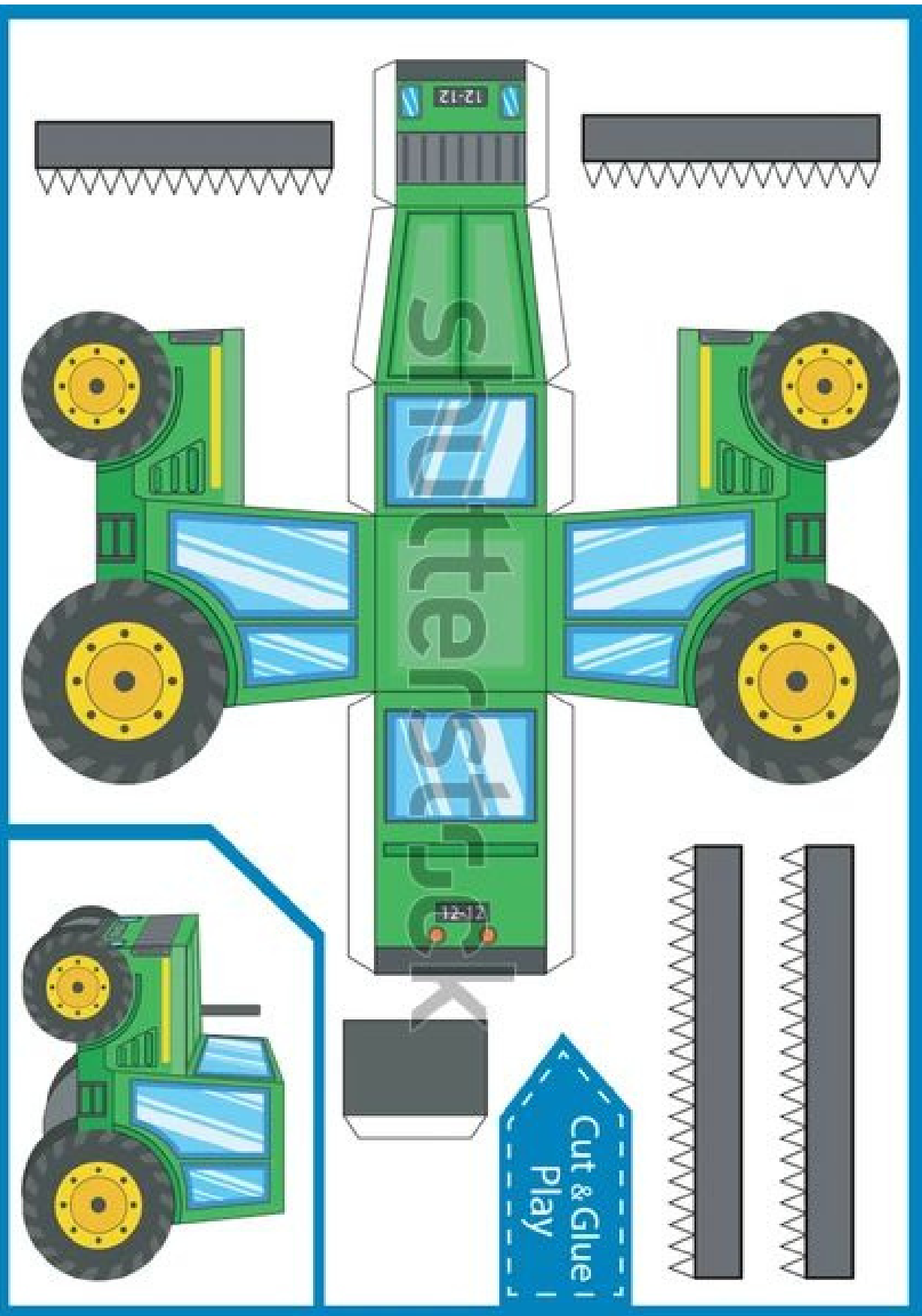

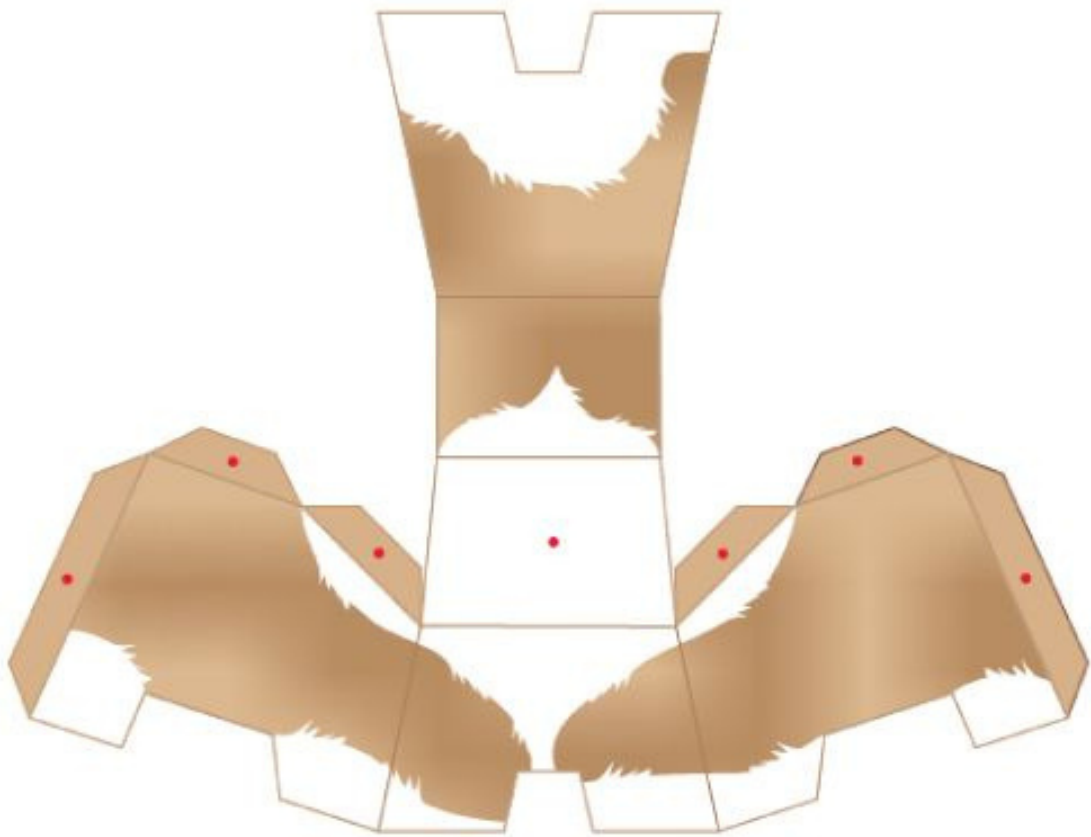
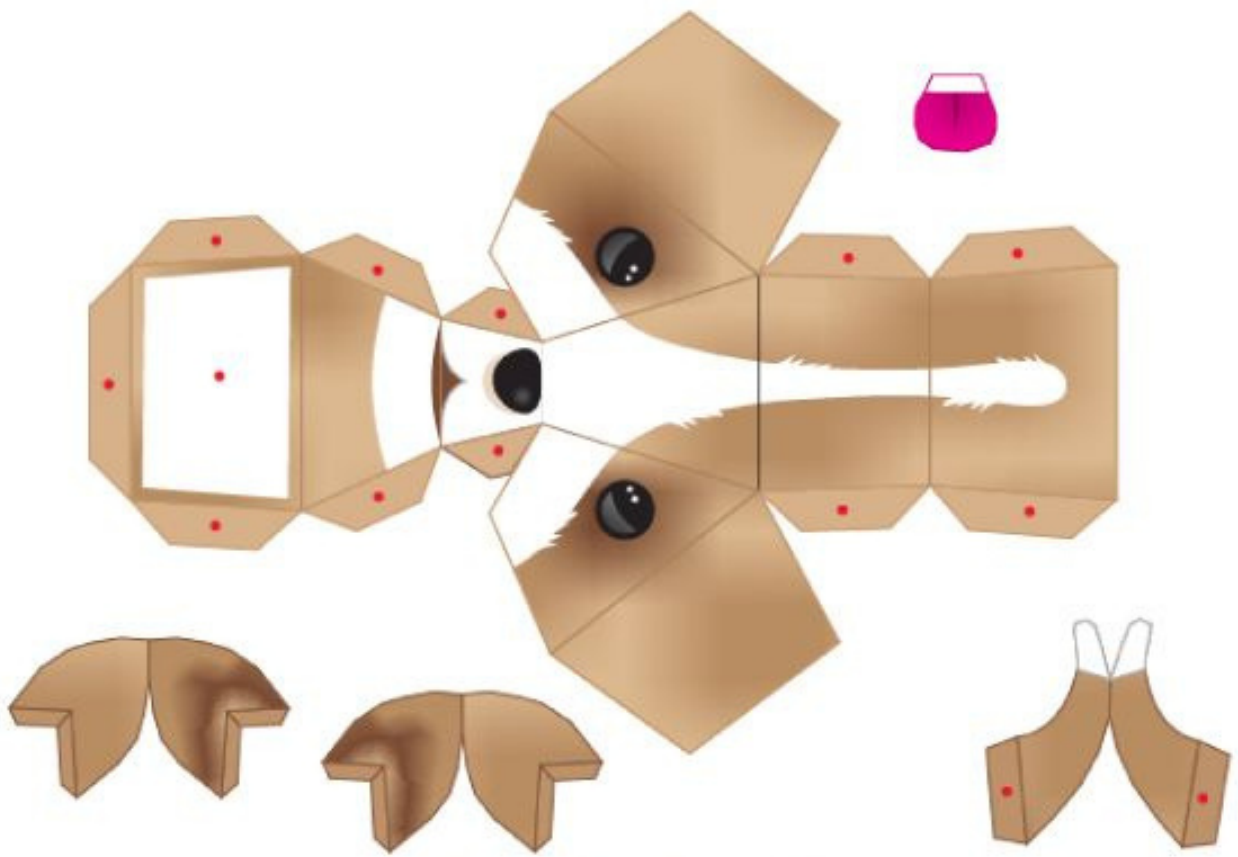

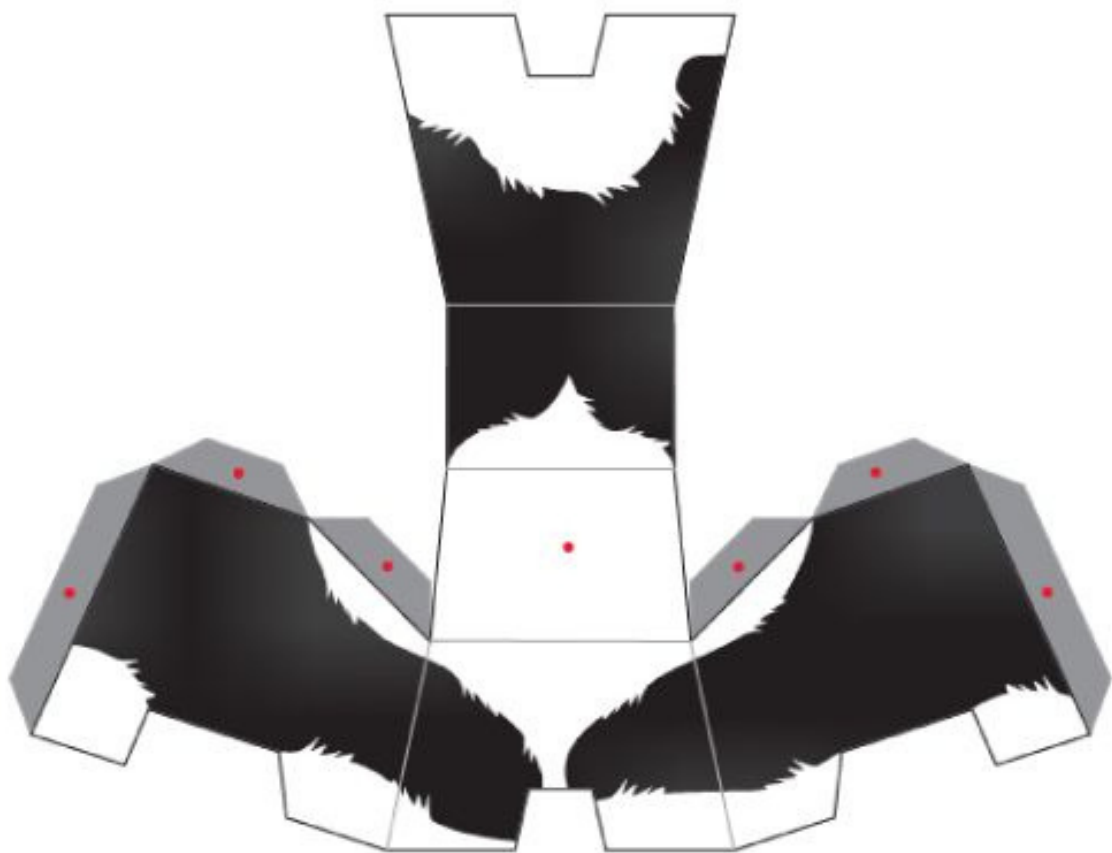
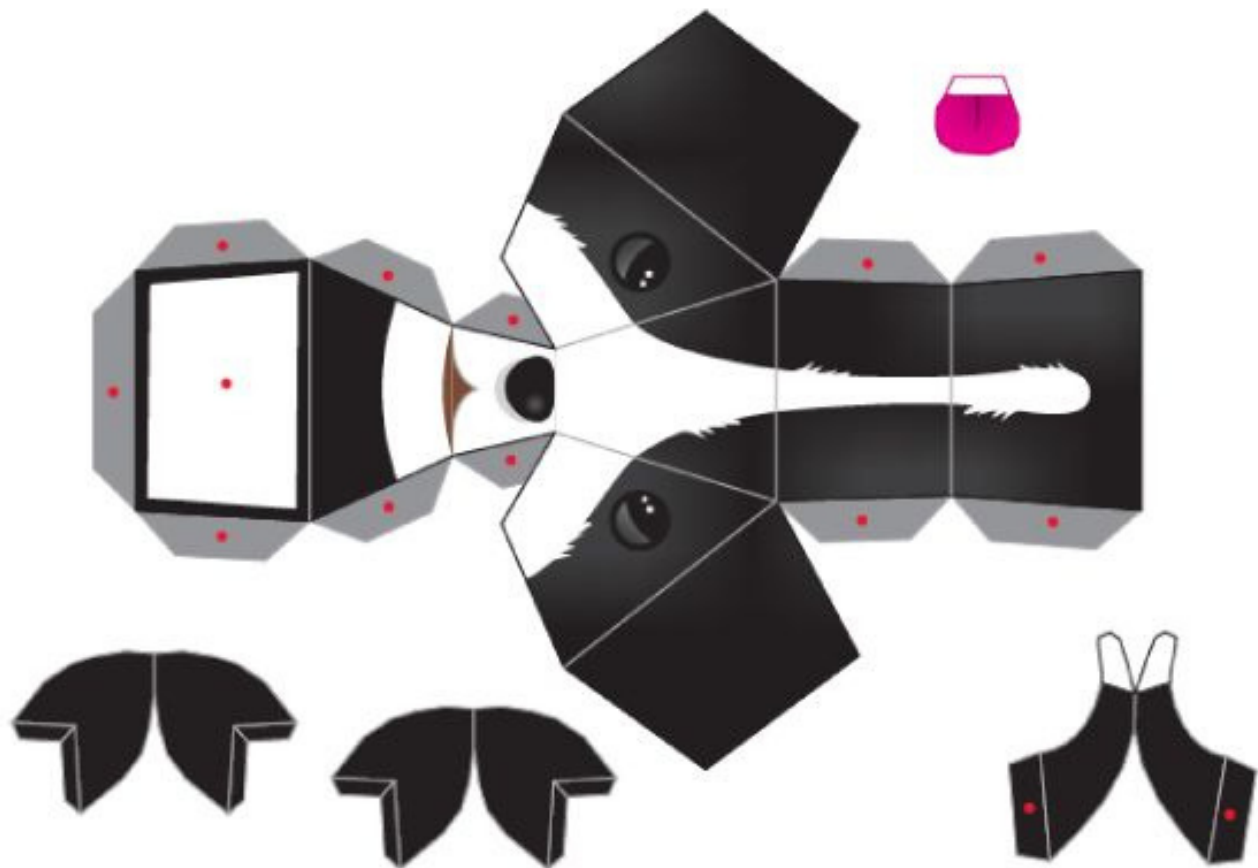

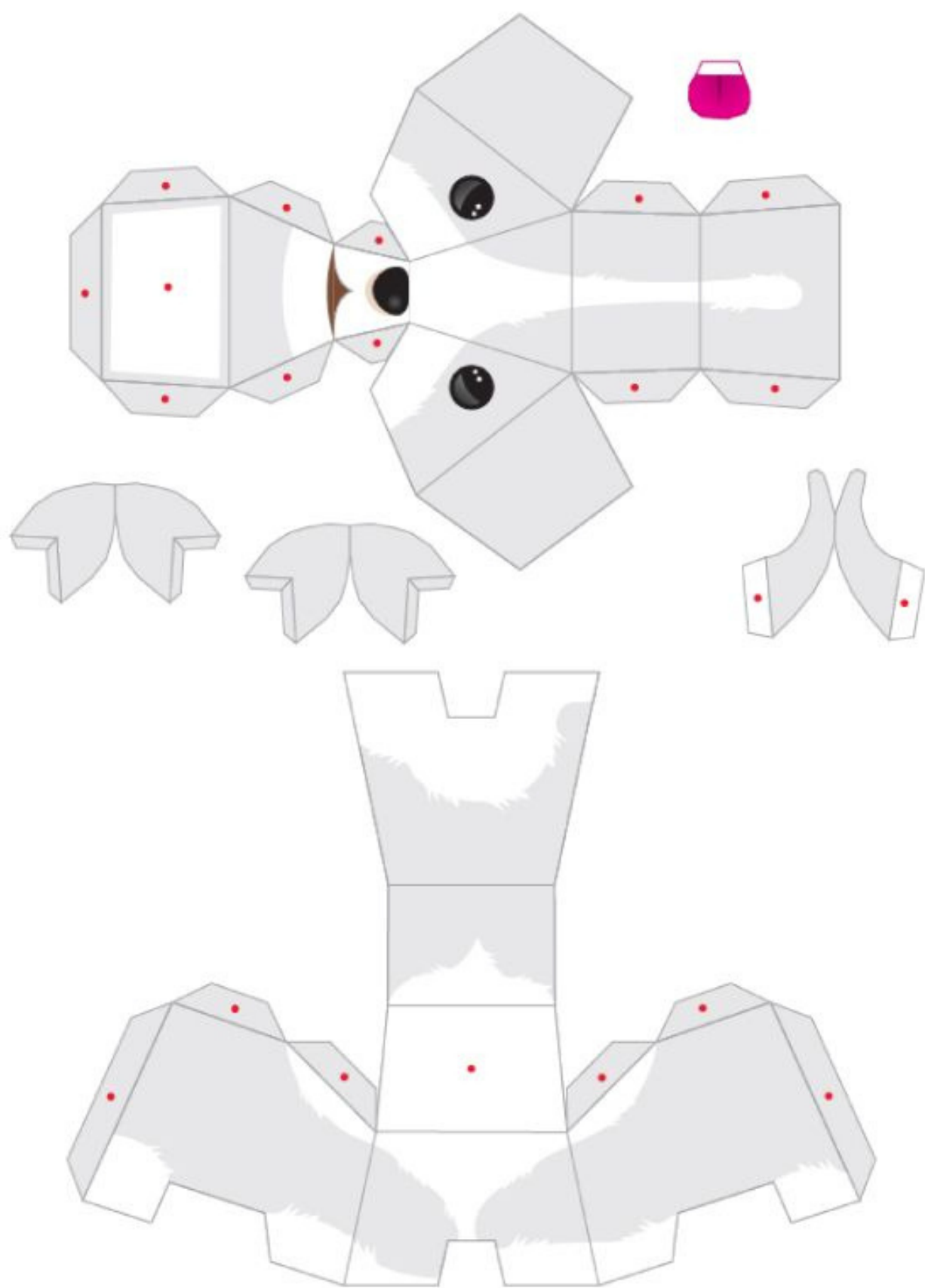

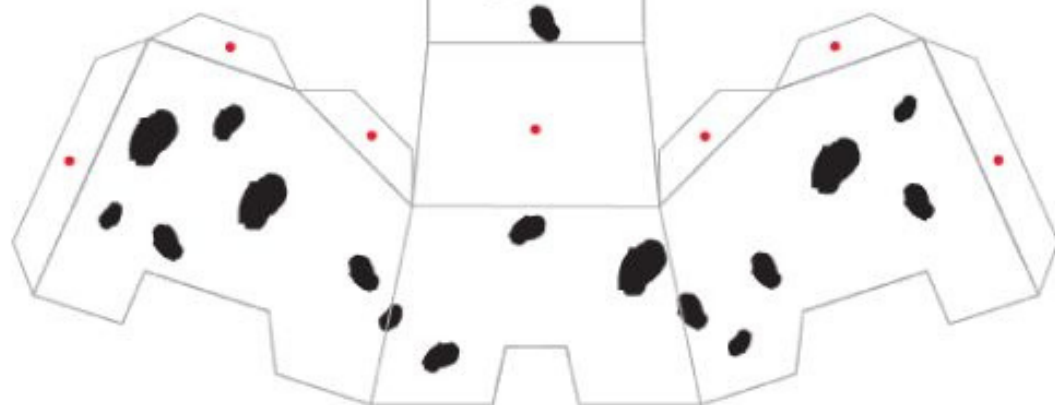
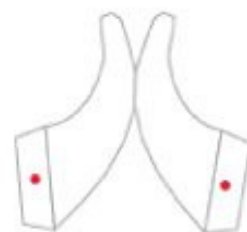
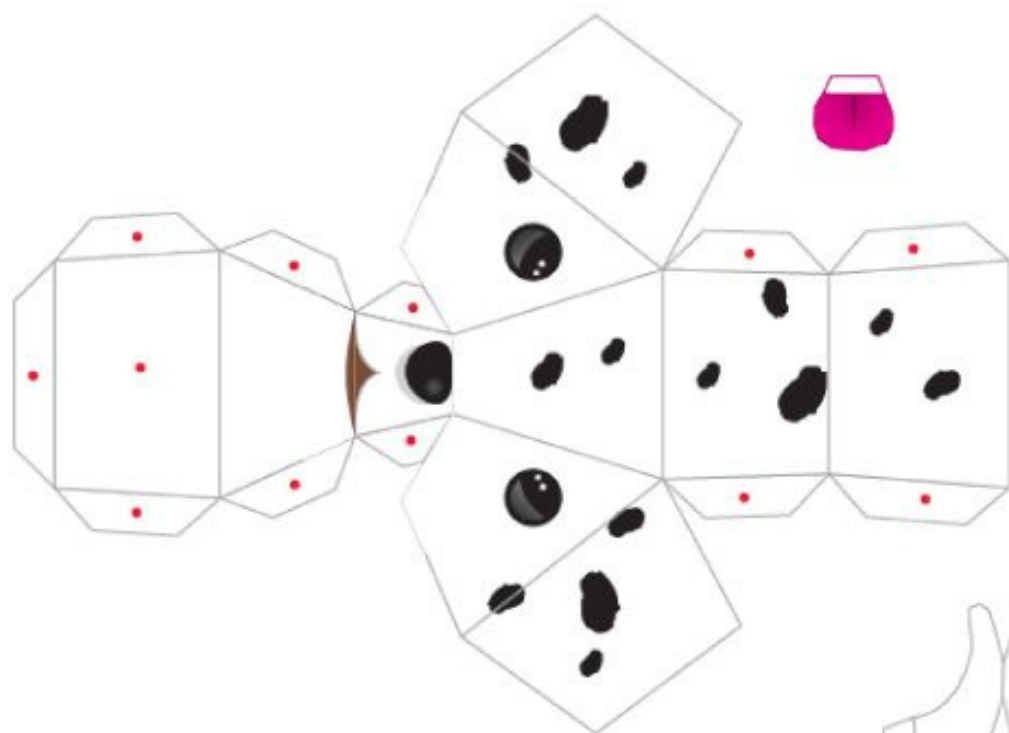

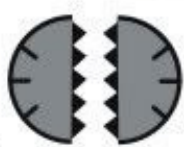

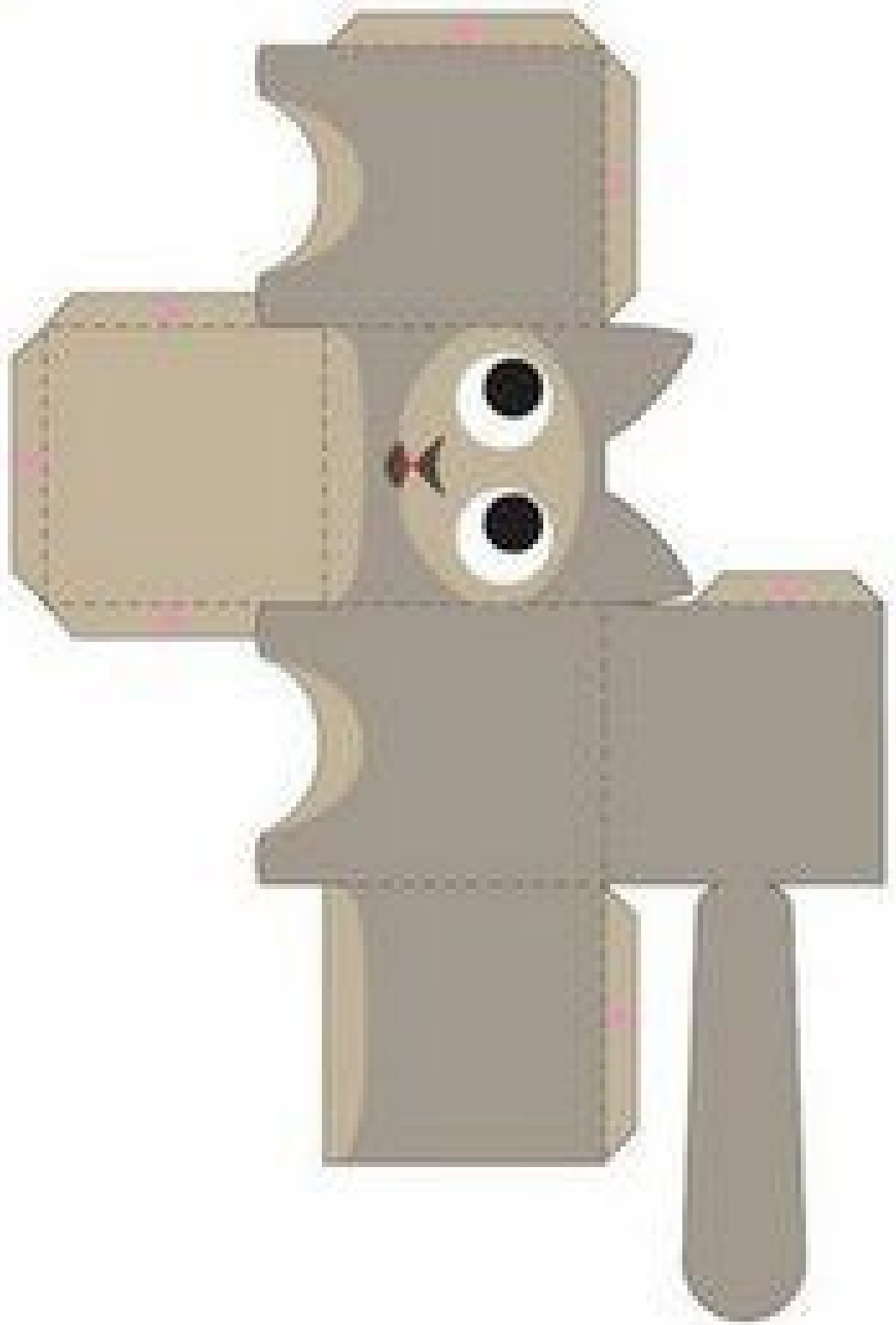
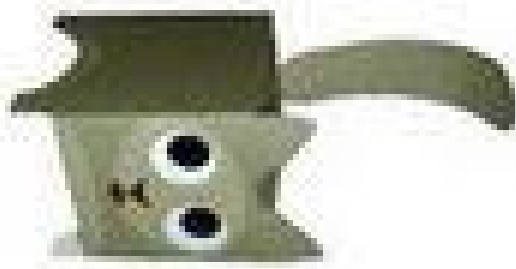

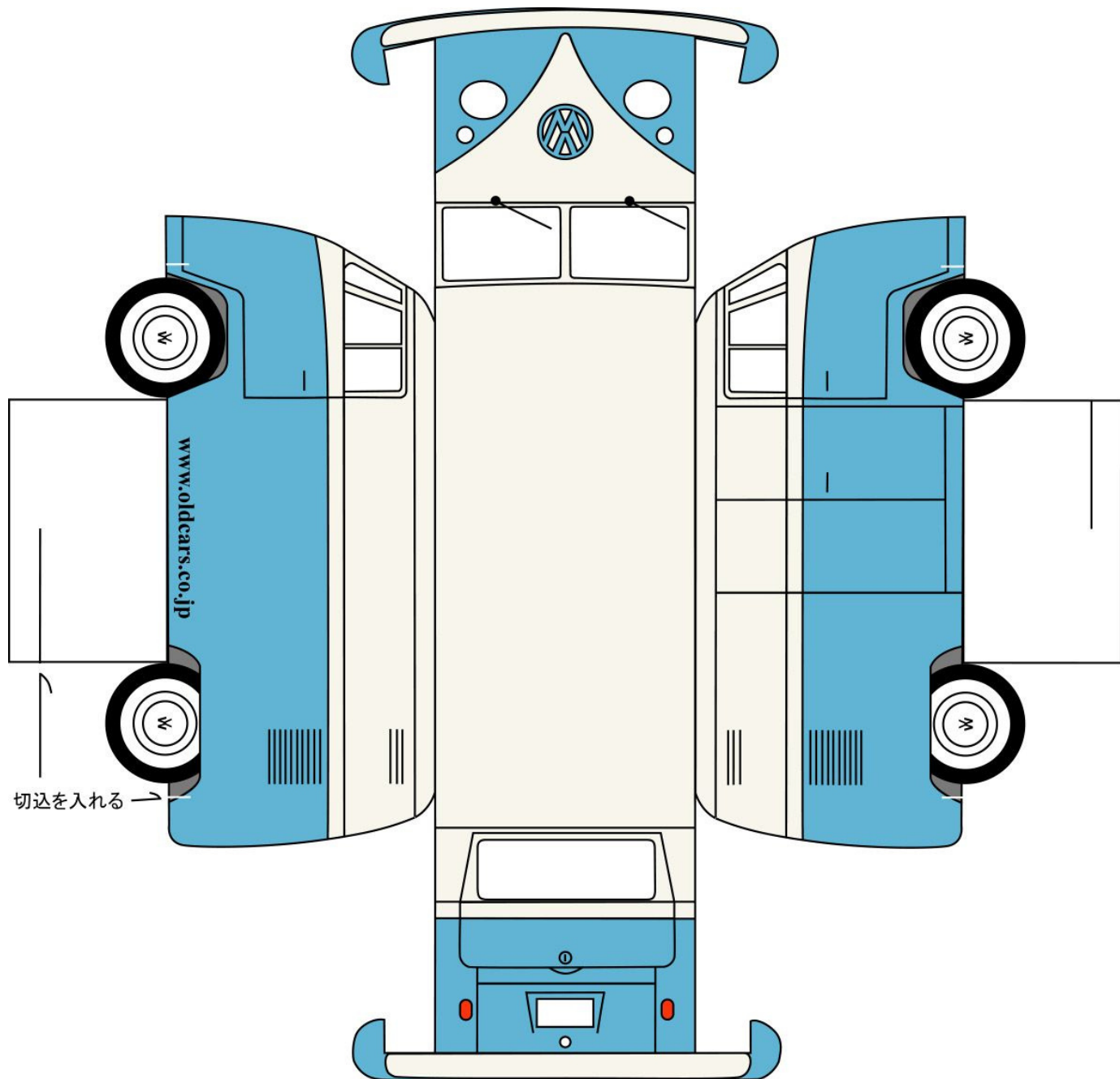

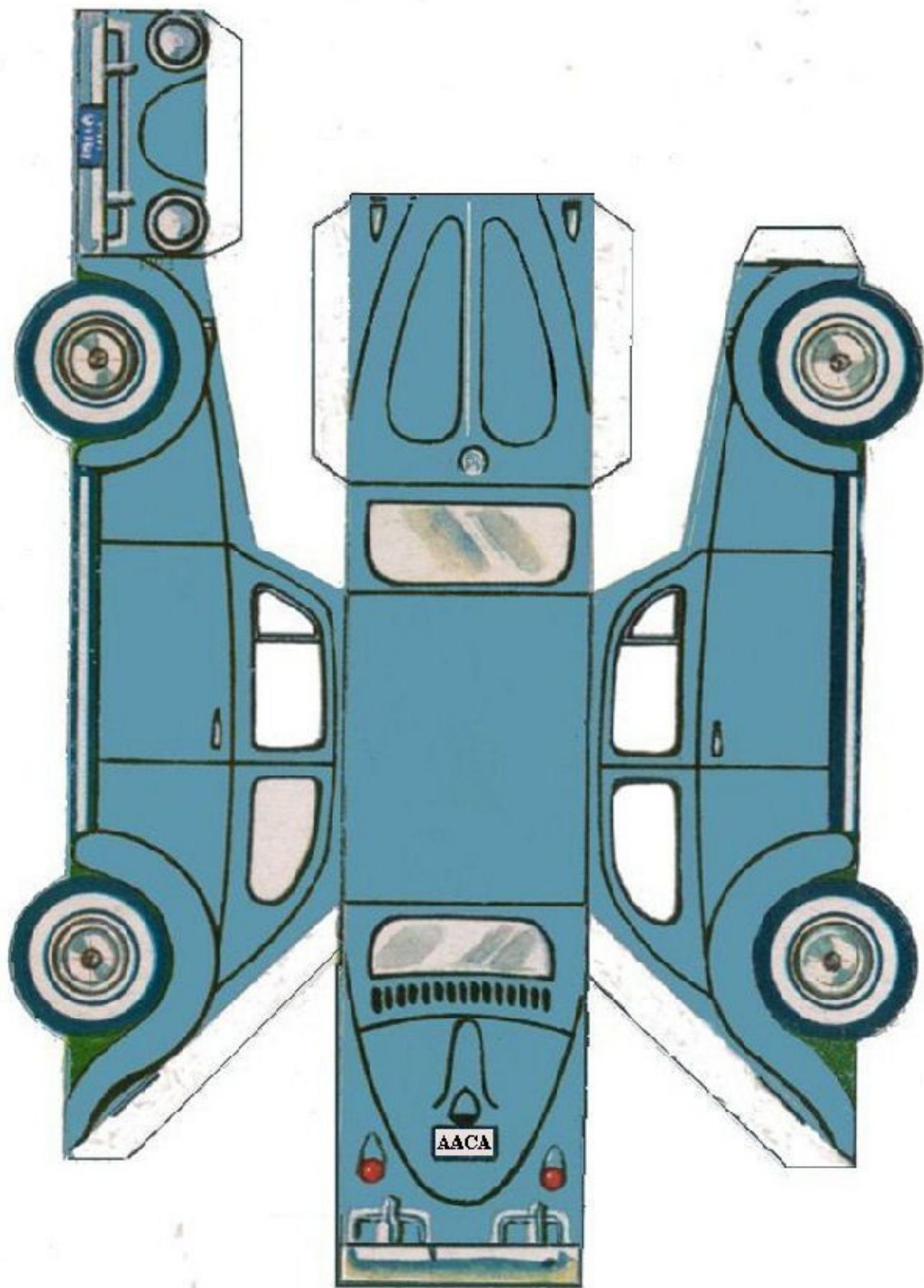

XDD

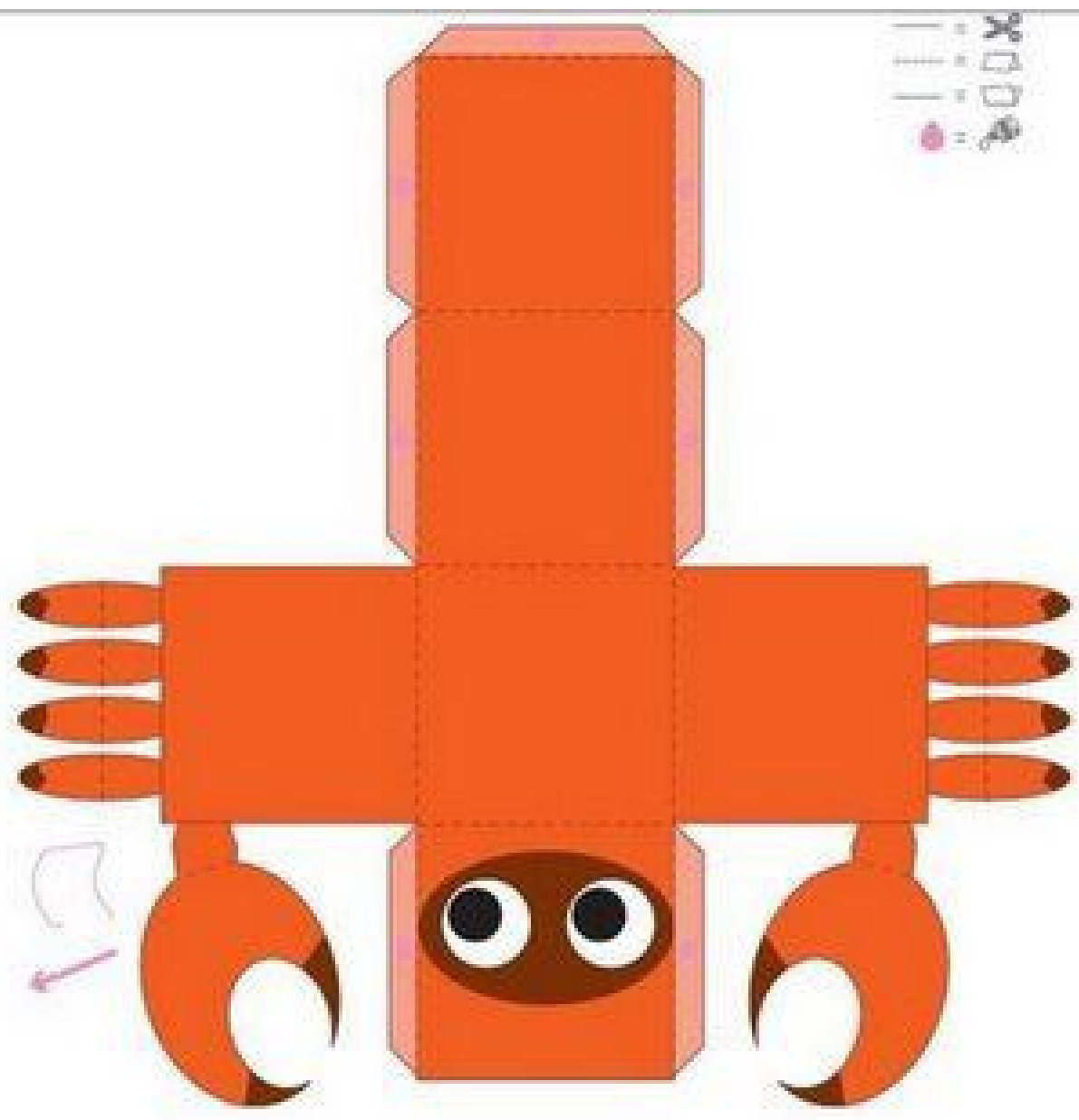

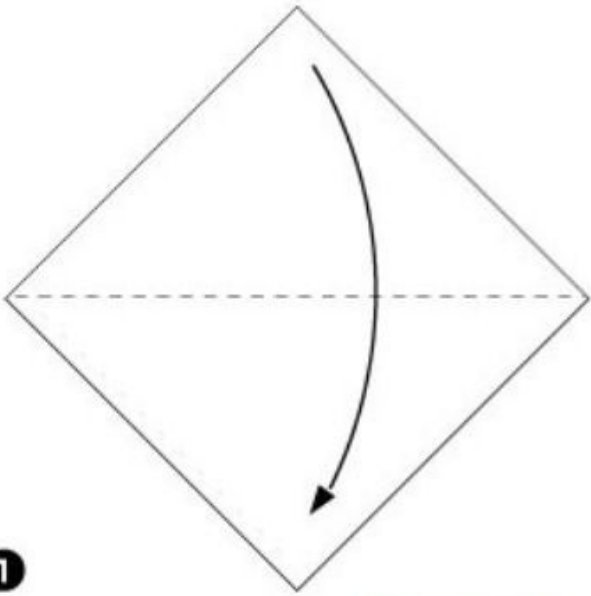

1

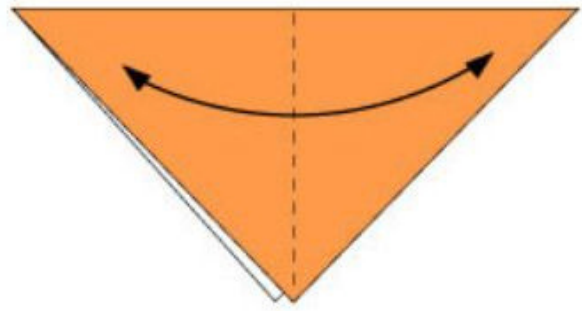

2

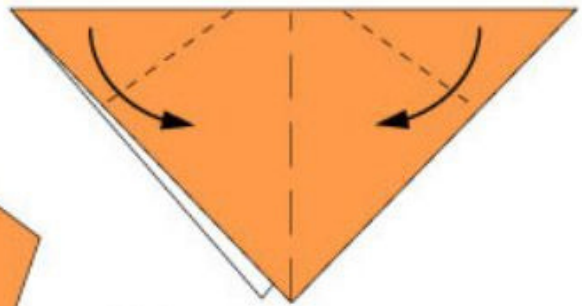

3

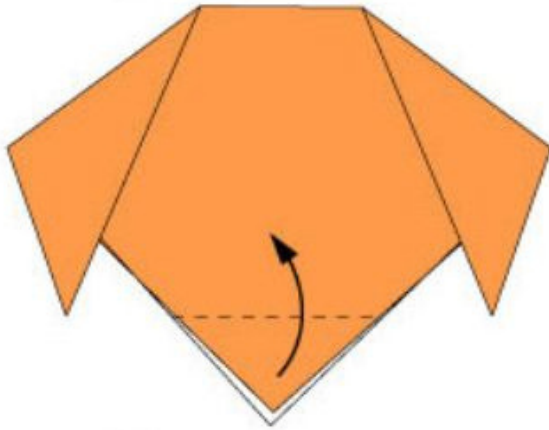

4

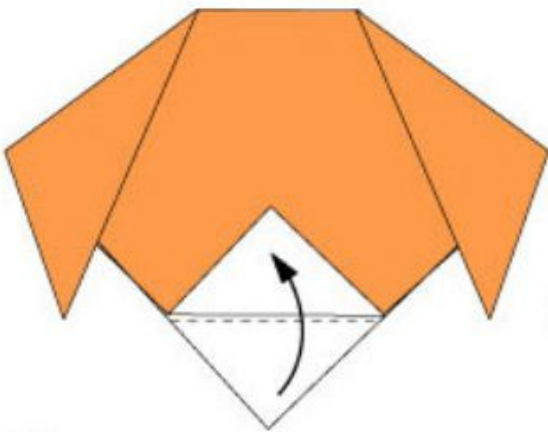

5

6

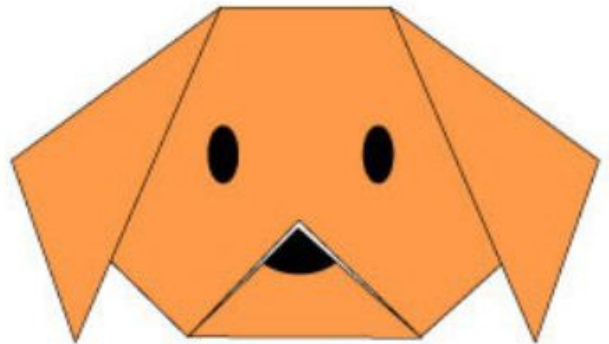

*Traditional
Diagram:Fumiaki Shingu

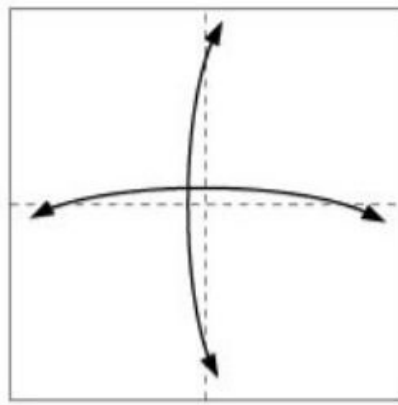

1

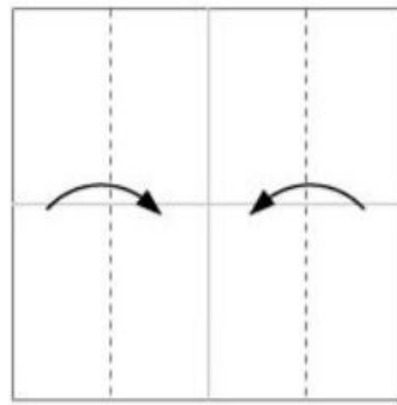

2

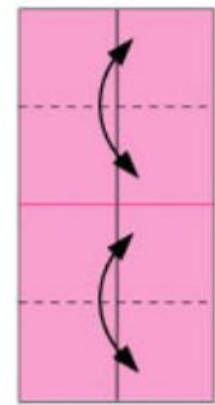

3

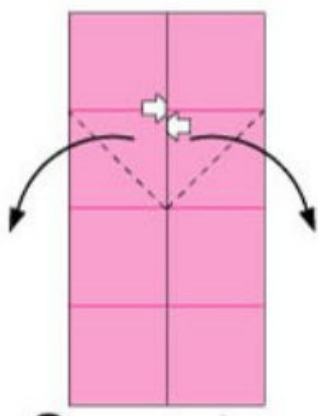

4

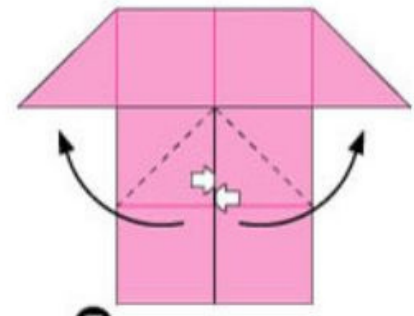

5

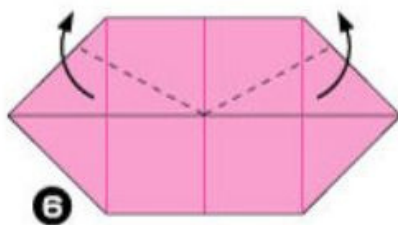

6

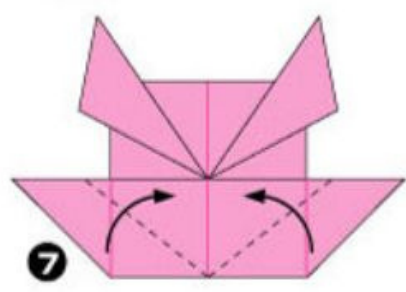

7

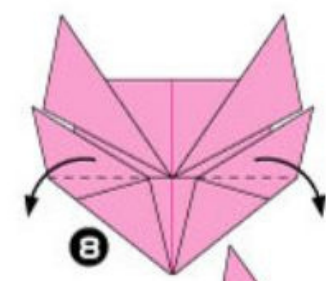

8

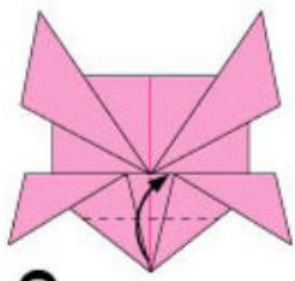

9

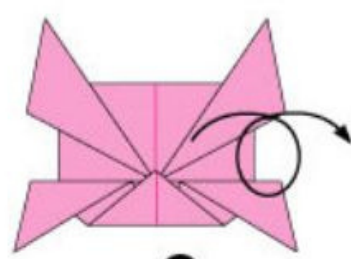

10

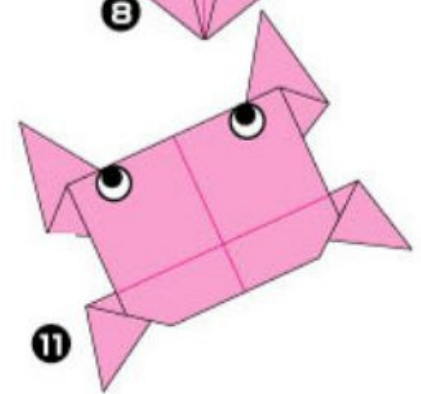

11

*Copyright:Fumiaki Shingu

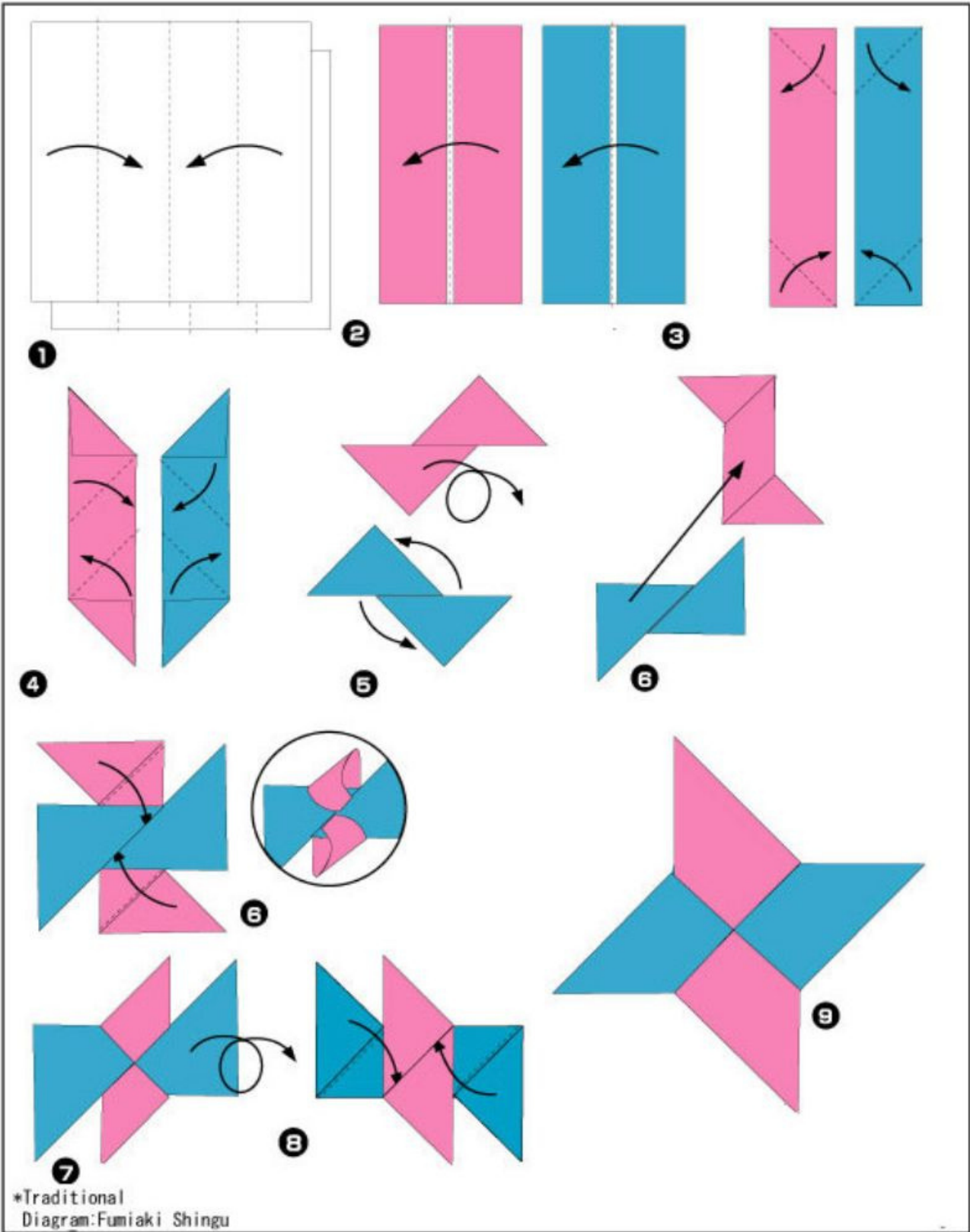

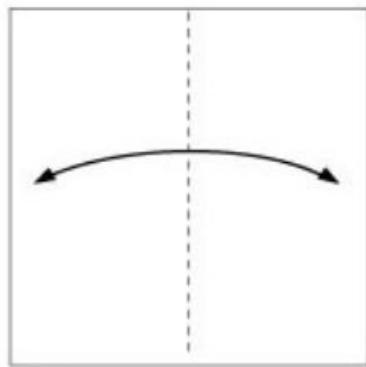

1

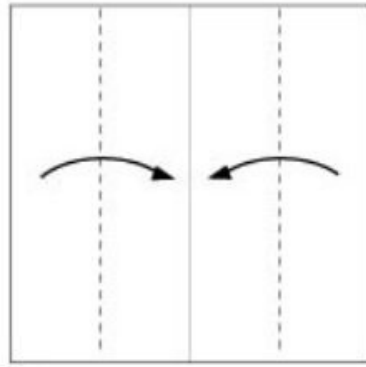

2



3

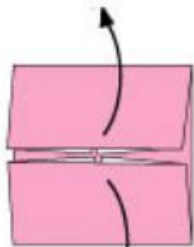

4

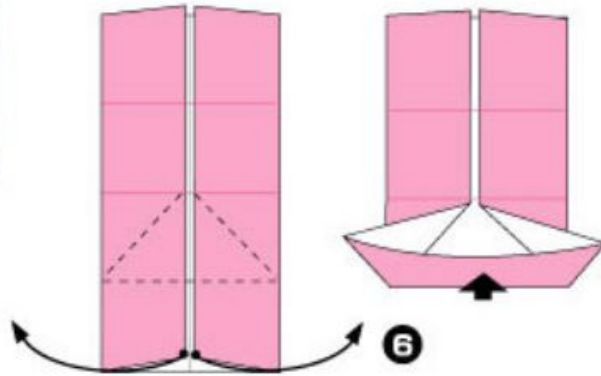

5

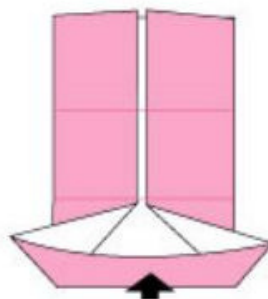

6

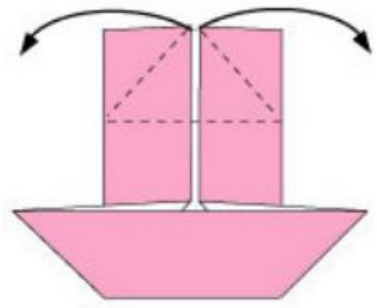

7

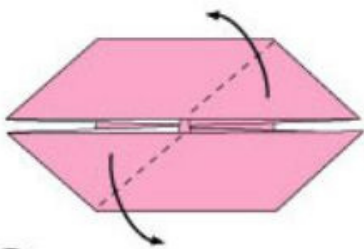

8

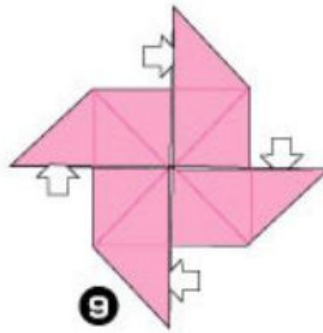

9

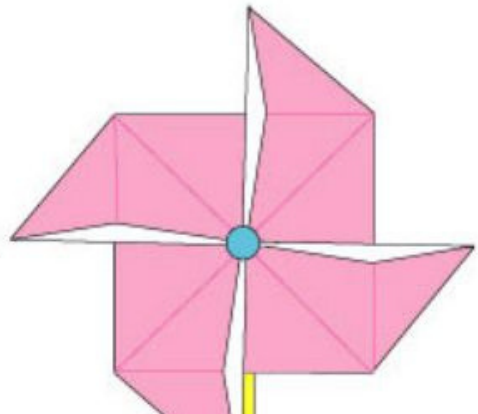

11



10

*Traditional Diagram:Fumiaki Shingu

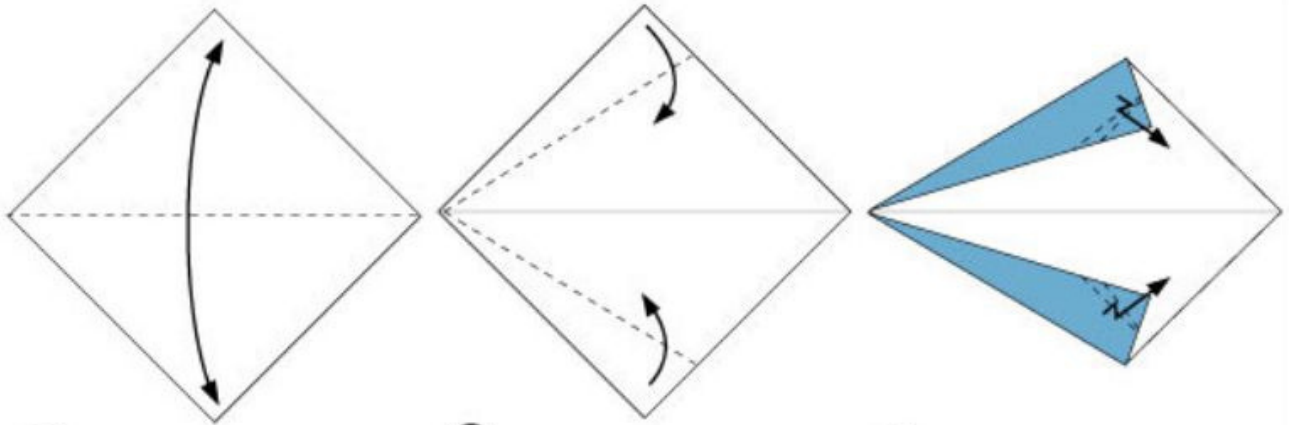

1

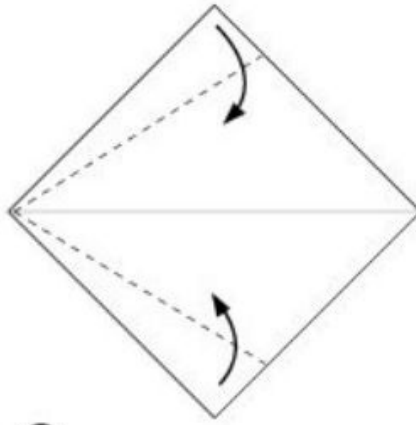

2

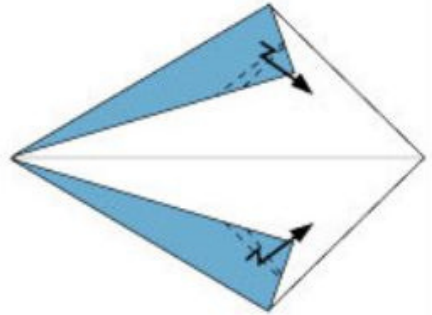

3

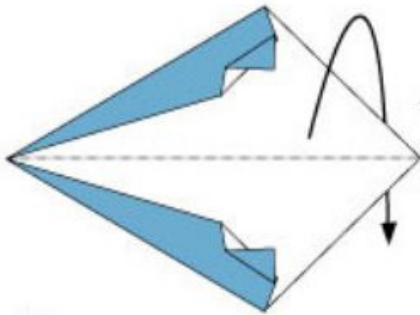

4

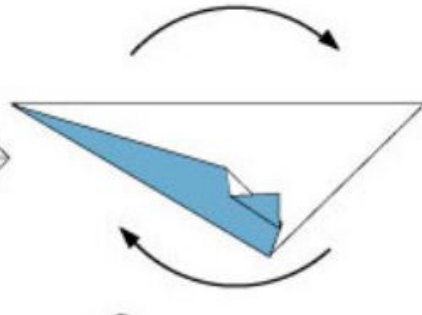

5

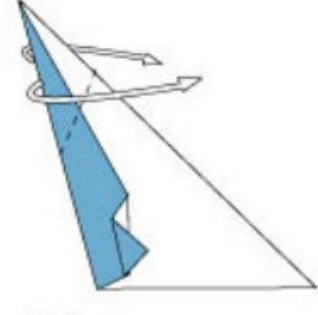

6

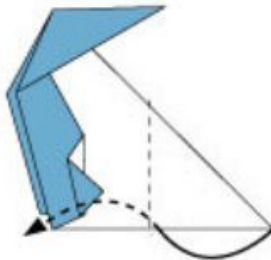

7



8

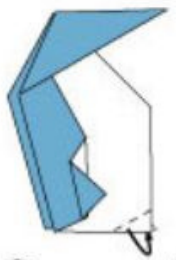

9

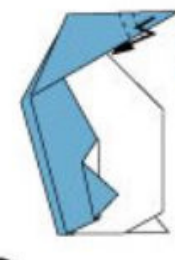

10



11

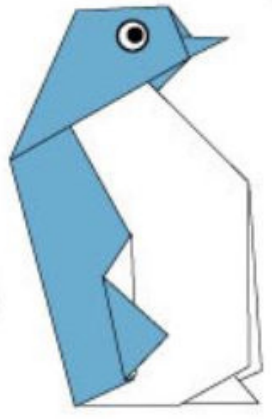

*Copyright:Fumiaki Shingu

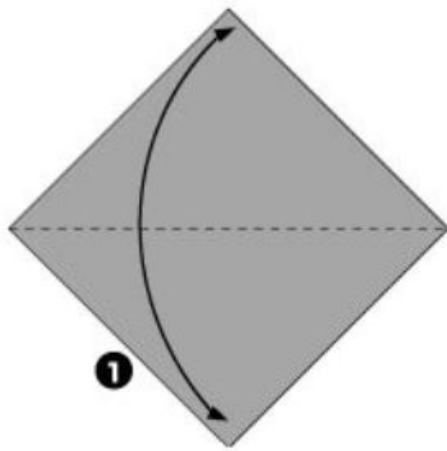

1

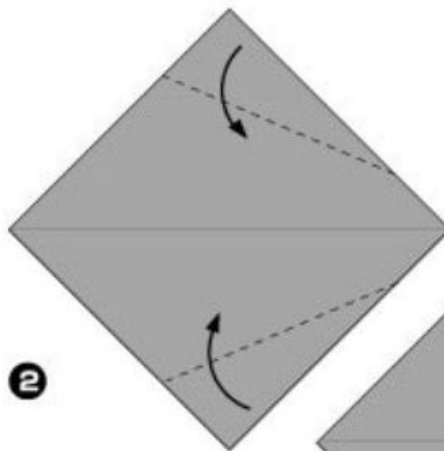

2

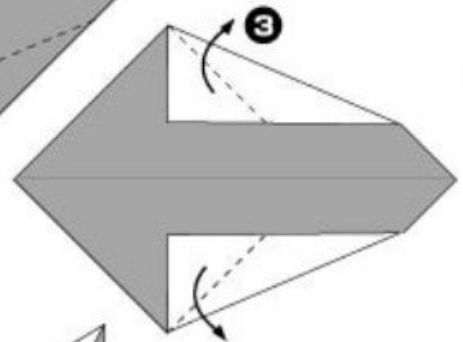

3

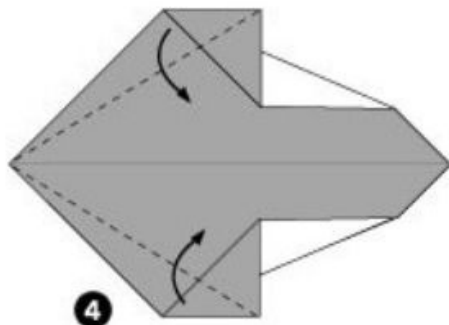

4

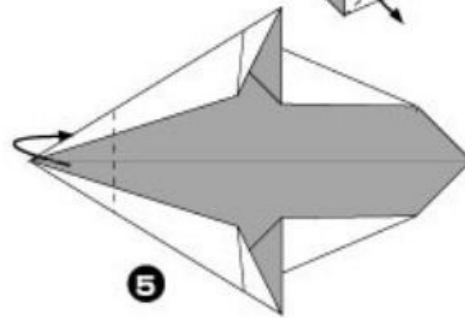

5

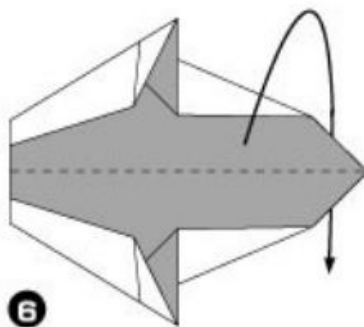

6

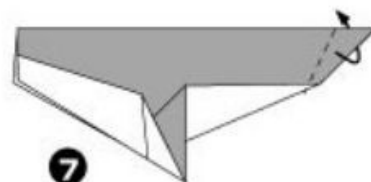

7

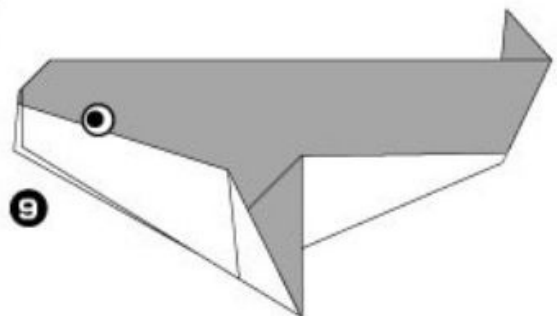

8

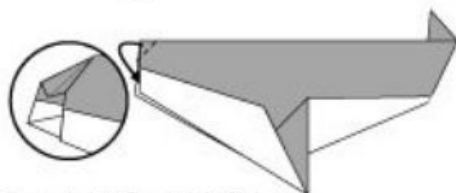

9

*Copyright:Fumiaki Shingu

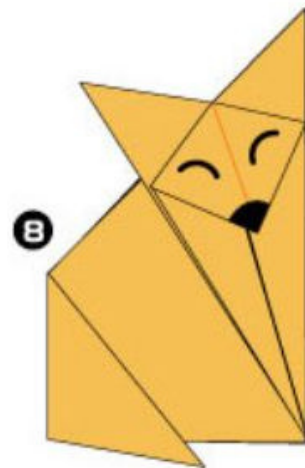
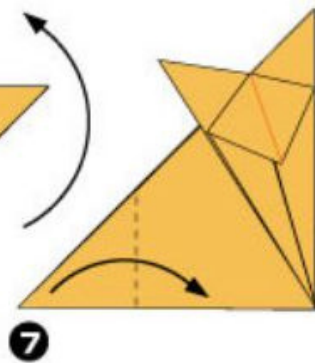
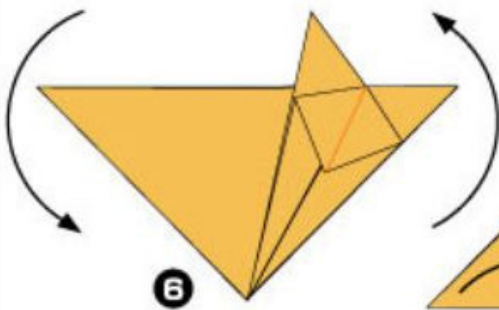
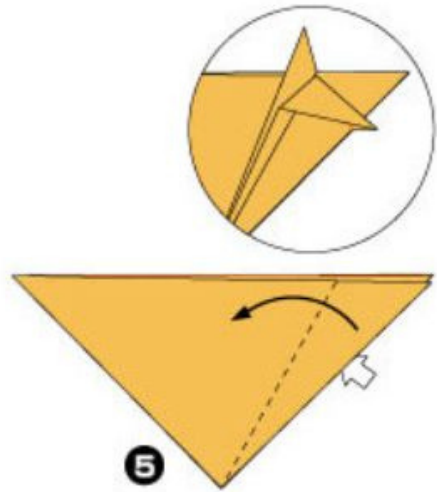
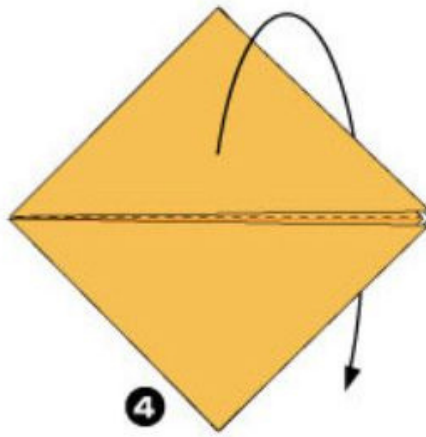
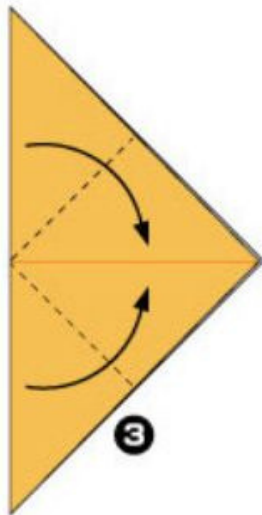
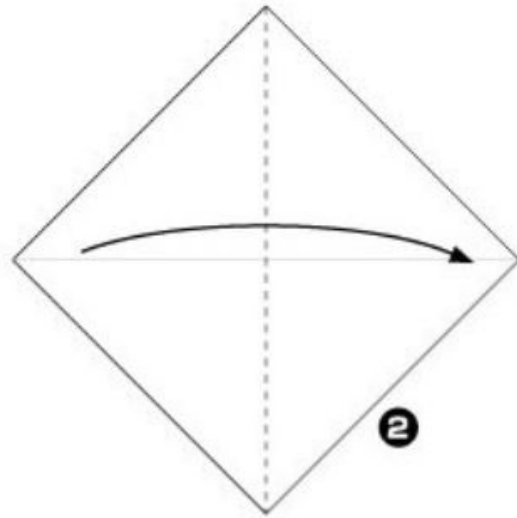
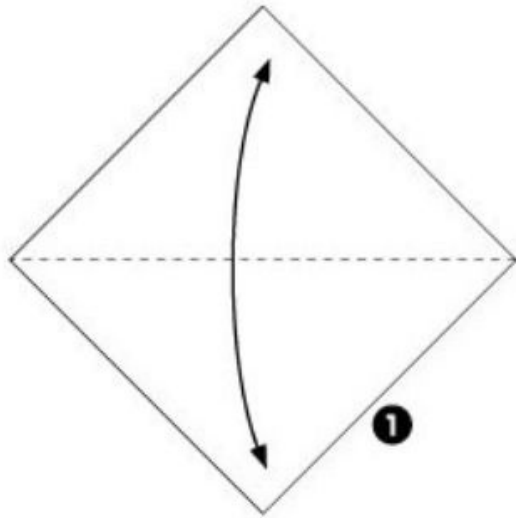

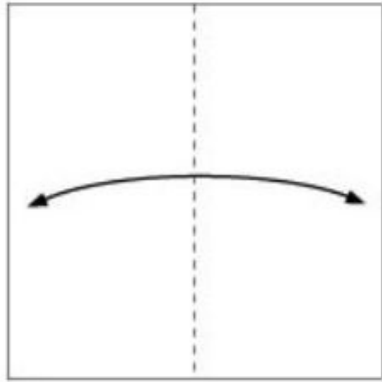

1

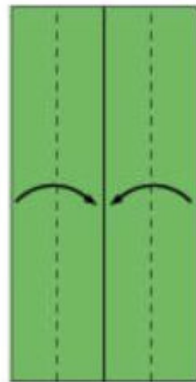

3

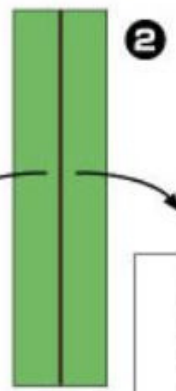

2

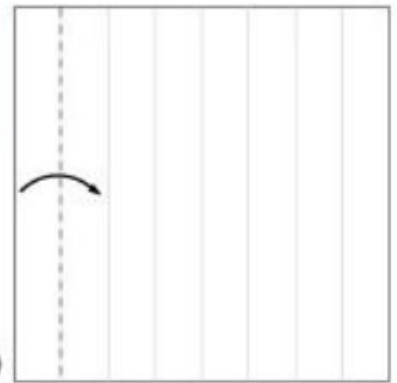

4

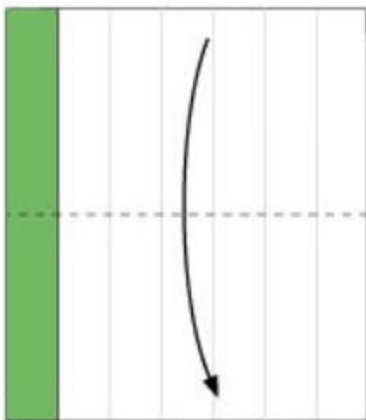

5

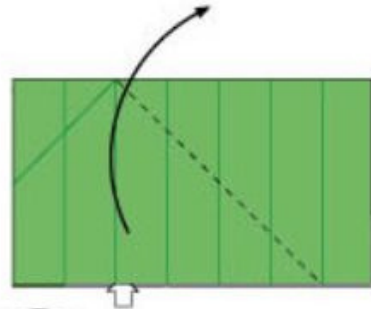

6

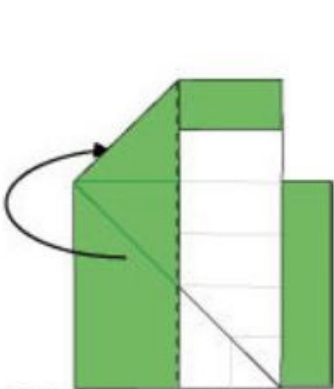

7



8

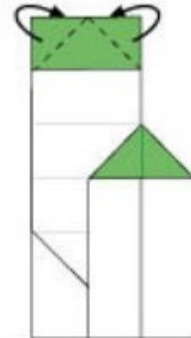

9

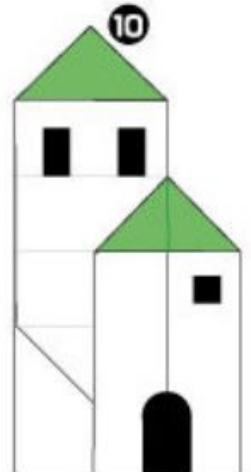

10

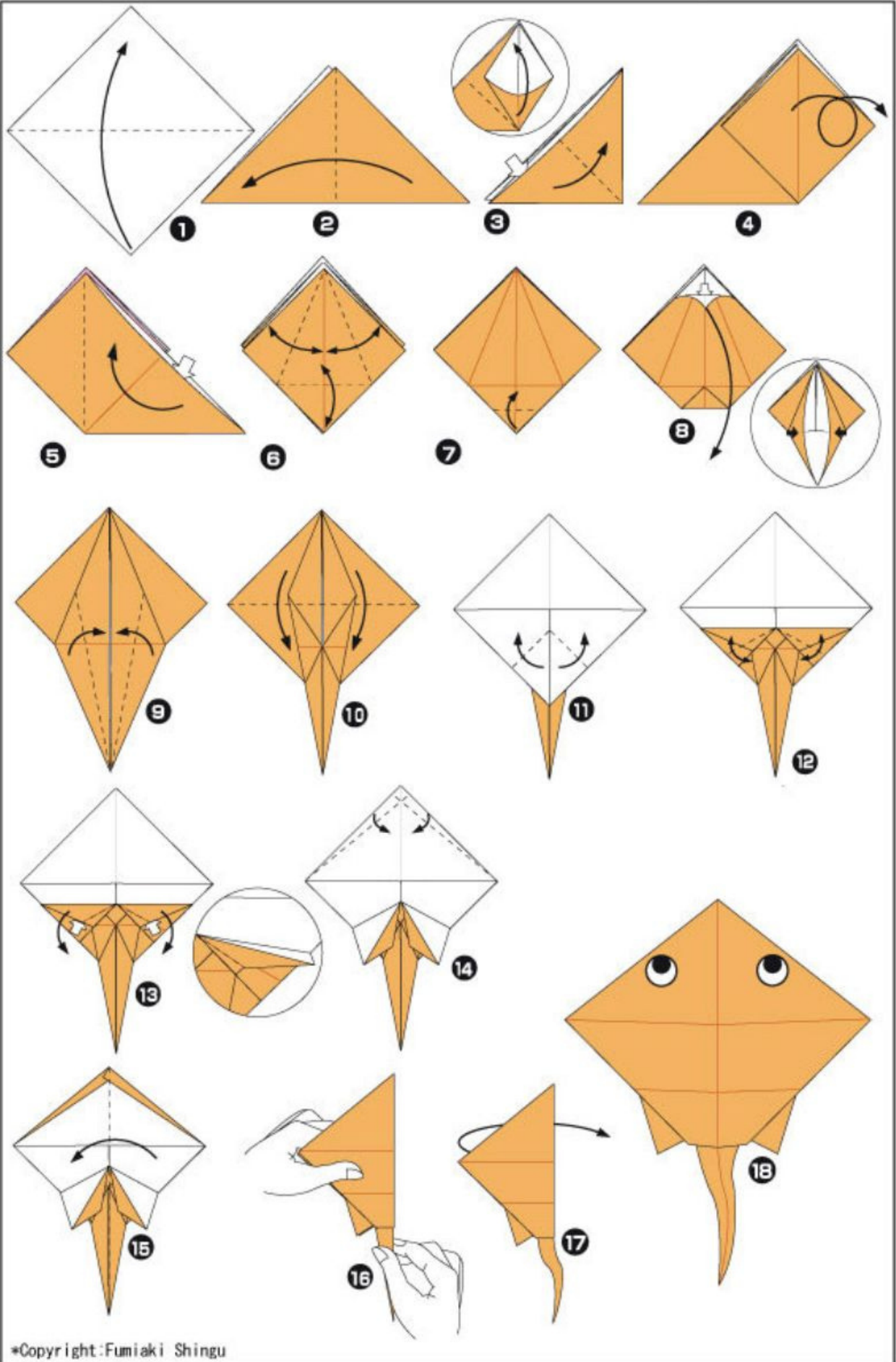

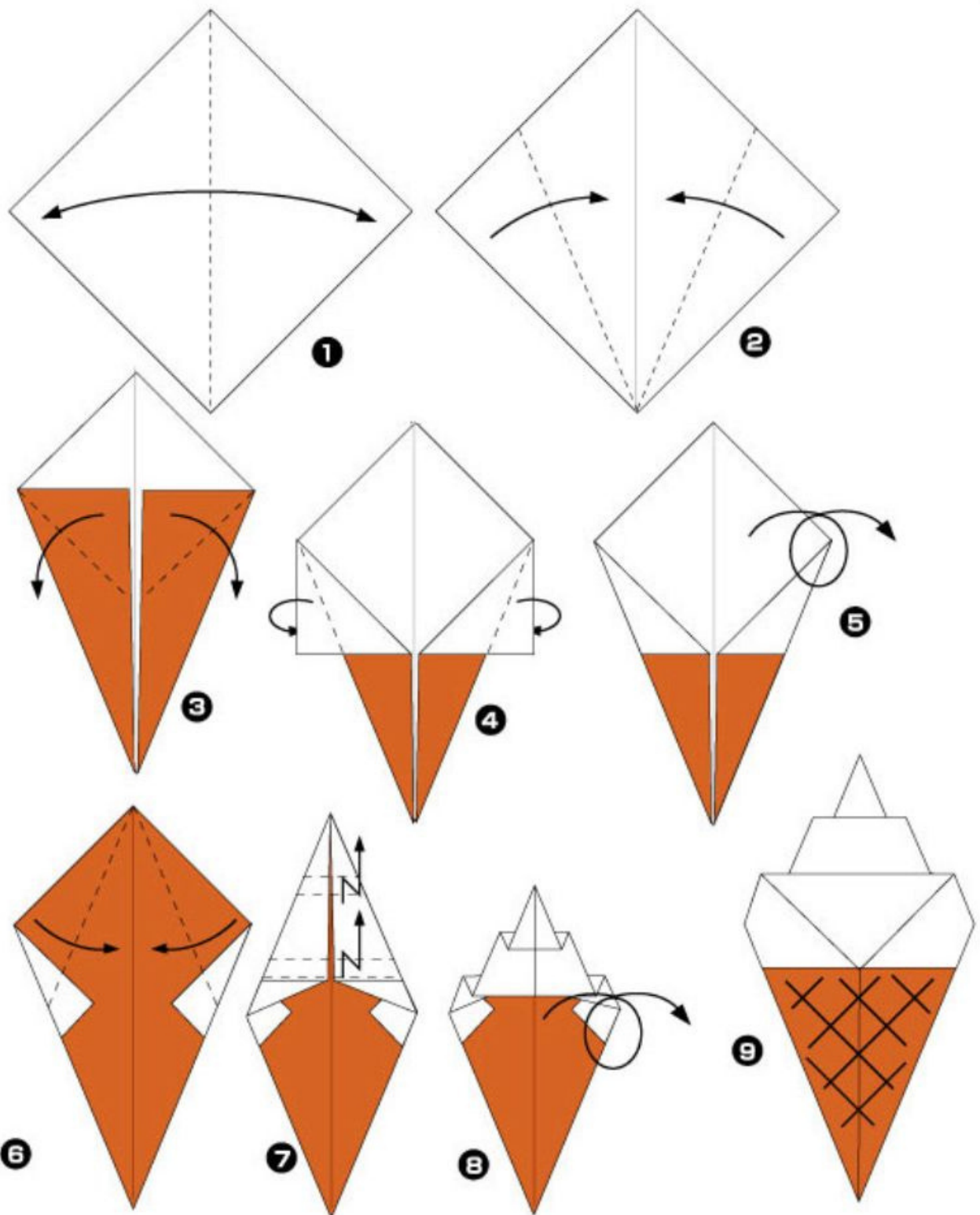

*Copyright:Fumiaki Shingu

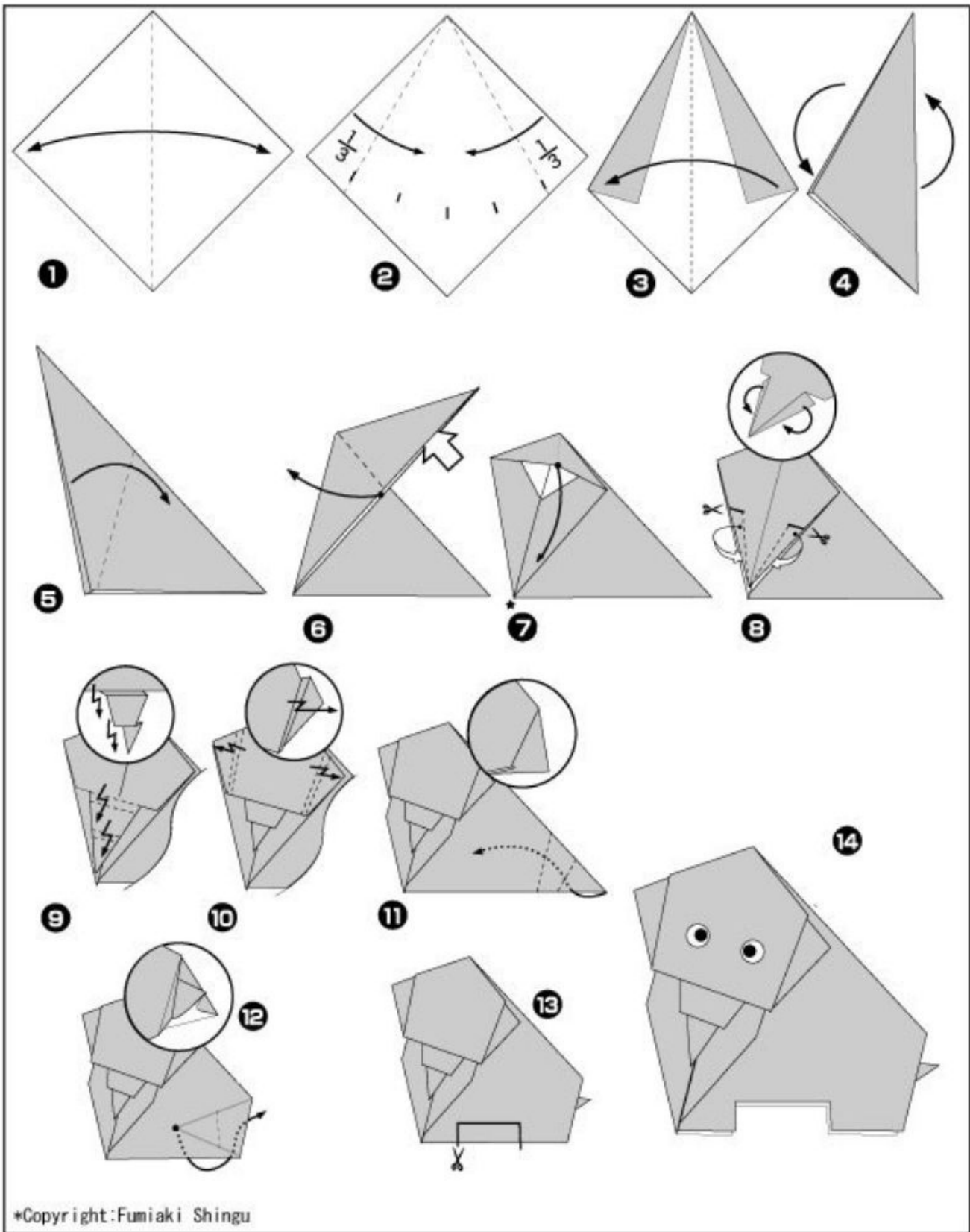

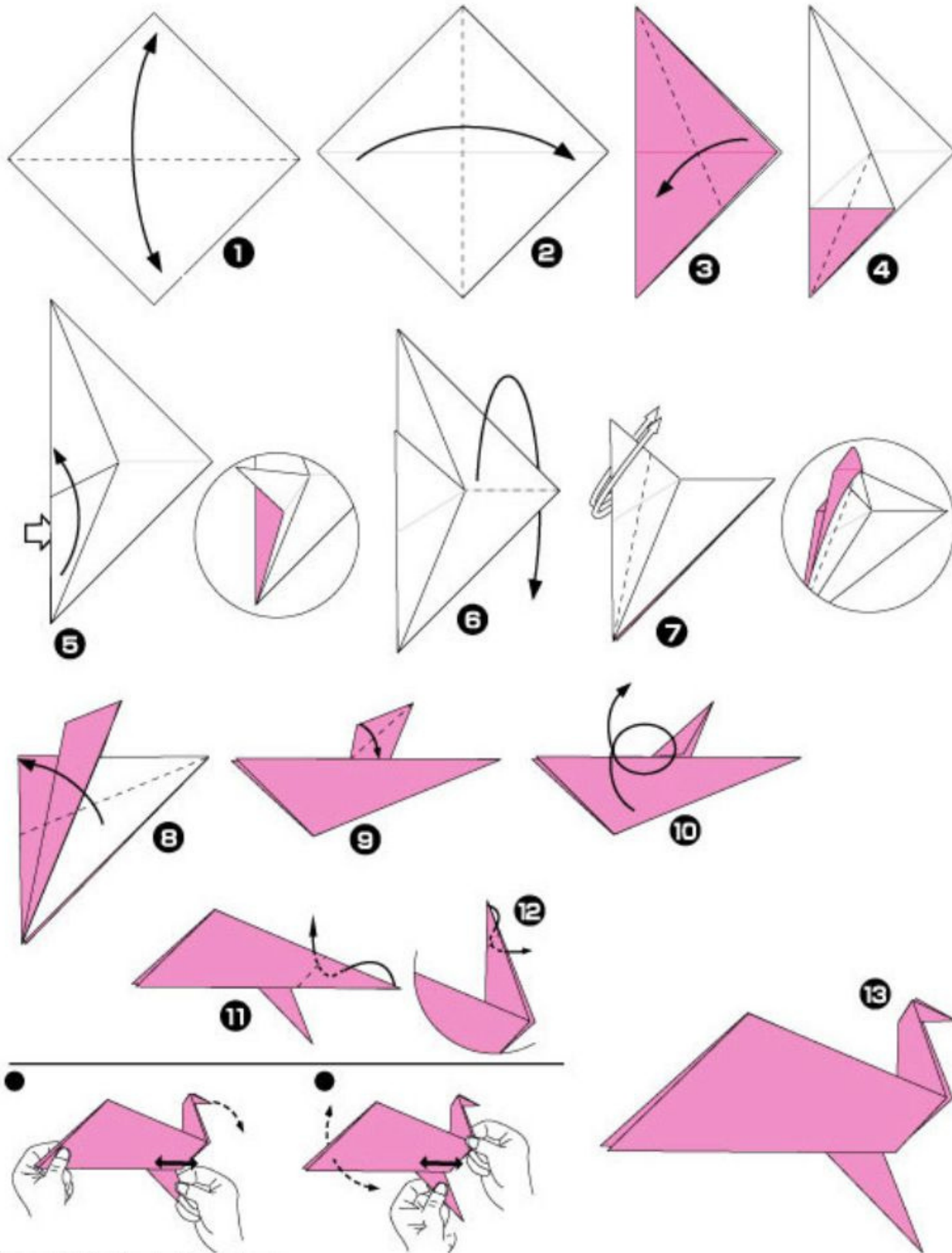

*Copyright:Fumiaki Shingu

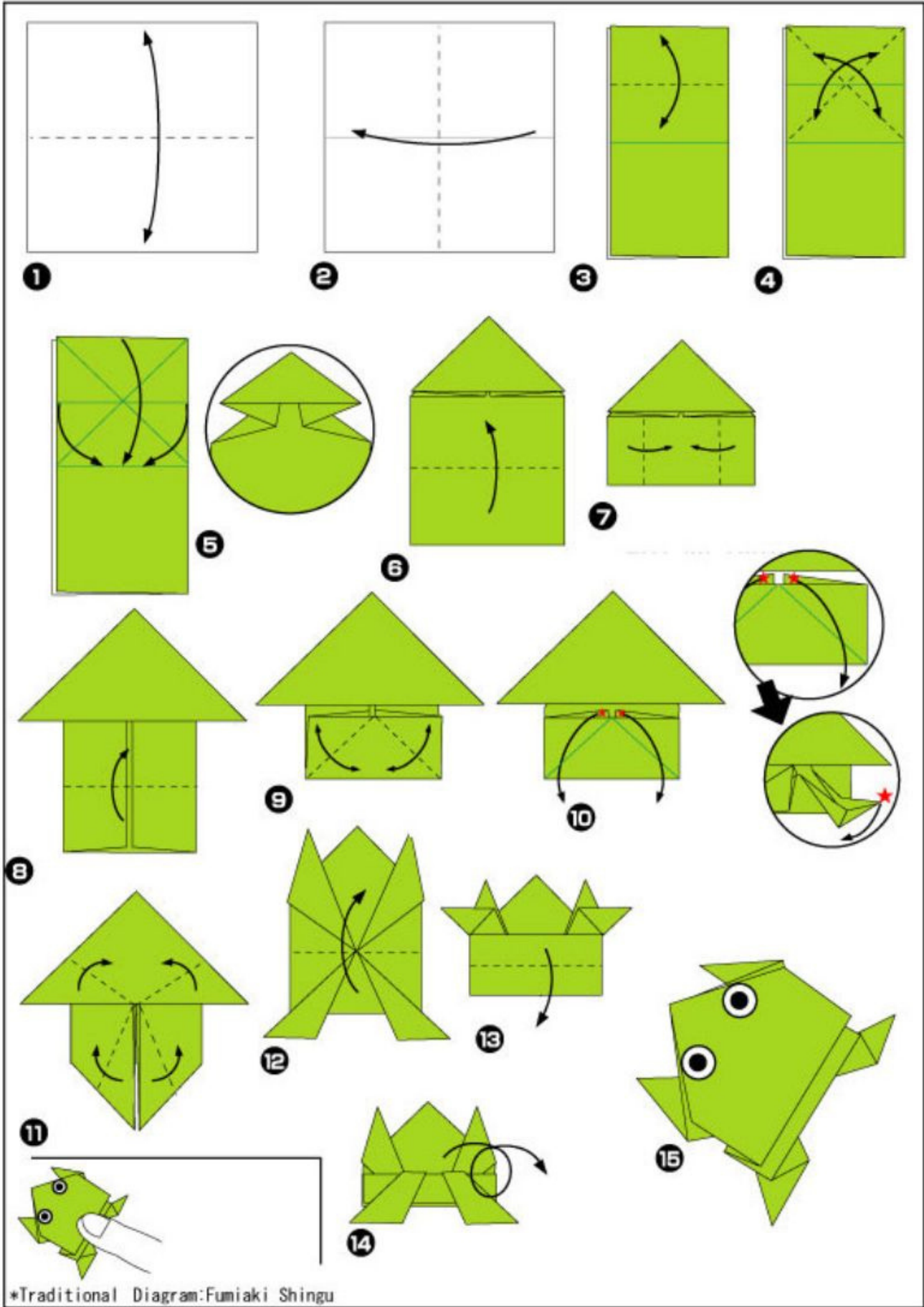

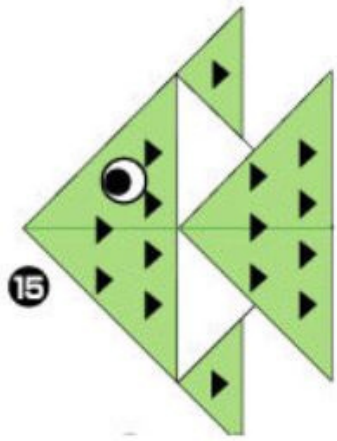
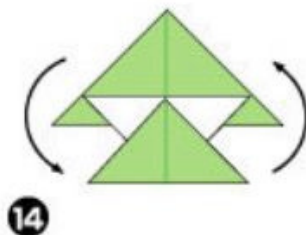
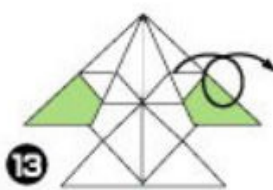
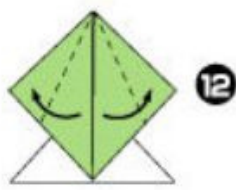
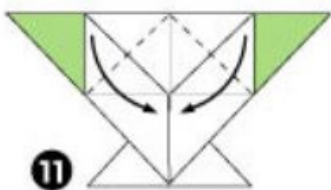
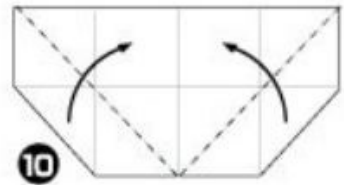
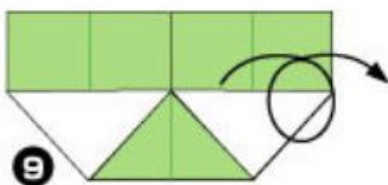
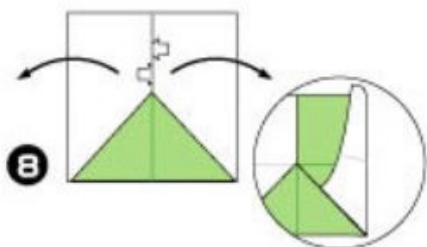
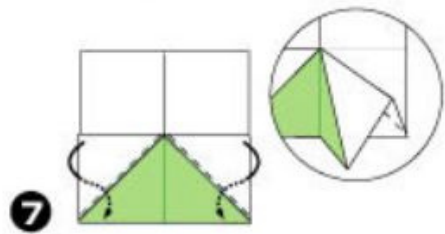
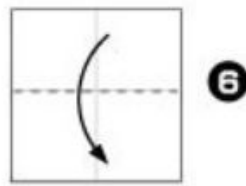
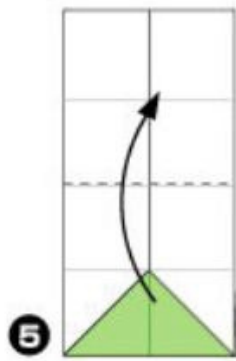
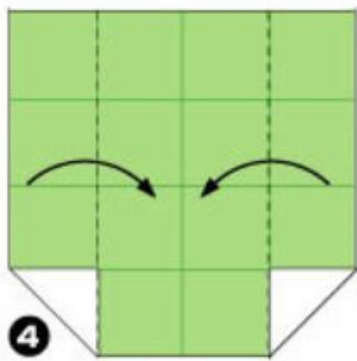
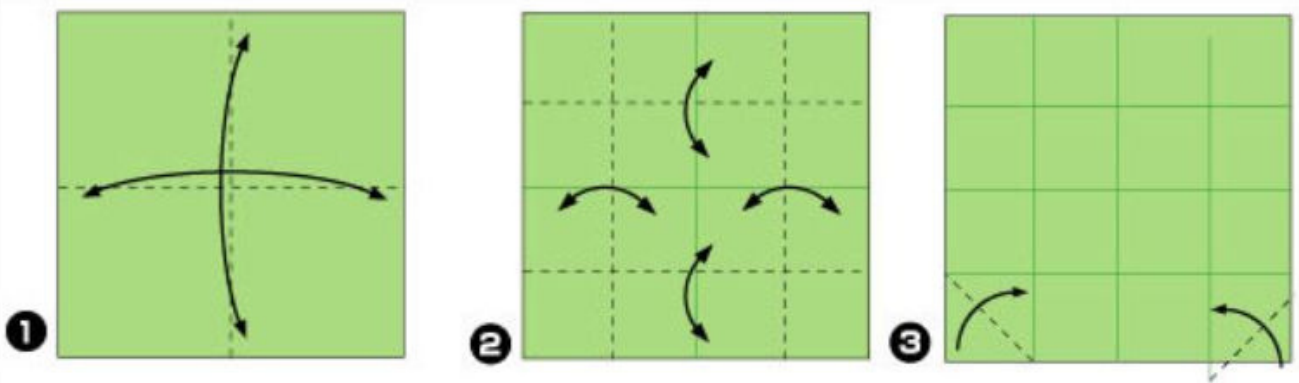

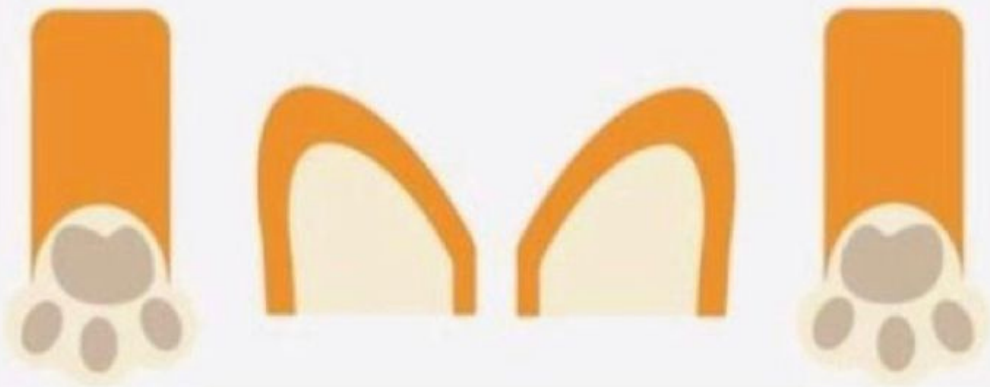

© 2013 Scholastic Teaching Resources
All rights reserved. No part of this publication may be reproduced, stored in a retrieval system, or transmitted, in any form or by any means, electronic, mechanical, photocopying, recording, or by any information storage and retrieval system, without the prior written permission of Scholastic Teaching Resources.

